

high performance through-beam sensors

- ▶ 1 channel amplifiers
- ▶ multi-channel multiplexers
- ▶ automatic amplifiers
- ▶ measuring amplifier
- ▶ transmitters and receivers
- ▶ fiber optics
- ▶ housings and accessories

index					page
					2
amplifiers for optical sensors OV6x					3
description OV6x					4
1 channel amplifier	1 x normally open contact				5
1 channel amplifier	1 x normally open contact			alarm output	6
1 channel amplifier	1 x normally open contact		0 to 10V DC	alarm output	7
1 channel amplifier	1 x change-over contact		time delay	alarm output	8
2 channel multiplexer	2 x normally open contact			alarm output	9
4 channel multiplexer	4 x normally open contact		0 to 10V DC	alarm output	10
8 channel multiplexer	8 x normally open contact		0 to 10V DC	alarm output	11
notes					12
amplifiers for optical sensors OV5x					13
description for 1 channel amplifiers					14
1 channel amplifier	1 x relay				15
1 channel amplifier	1 x relay	1 x pnp / npn			16
1 channel amplifier	1 x relay	1 x pnp / npn	time delay		17
1 channel amplifier	1 x relay	1 x pnp / npn	time delay	alarm output	18
1 channel automatic amplifier	1 x relay	1 x pnp / npn		alarm output	19
1 channel automatic amplifier	1 x relay	1 x pnp / npn	time delay	alarm output	20
1 channel automatic amplifier	1 x relay	1 x pnp / npn	teach-in	alarm output	21
1 channel measuring amplifier	1 x relay	1 x pnp / npn	0 to 10V DC		22
notes					23
notes					24
multiplexer for optical sensors OV5x					25
description for multiplexers					26
2 channel multiplexer	2 x relay				27
2 channel multiplexer	2 x relay		time delay		28
2 channel automatic multiplexer	2 x relay				29
4 channel multiplexer		4 x pnp / npn	time delay		30
4 channel multiplexer	4 x relay		time delay		31
8 channel multiplexer	8 x relay		time delay		32
8 channel automatic multiplexer	8 x relay		time delay	alarm output	33
transmitter and receiver					34
transmitter and receiver wiring diagrams					35
fiber optics					36
accessories					37
protective housings					38

design **38.5 x 90 x 58.5mm**
to
158.5 x 90 x 58.5mm

through-beam sensor operating distance **up to 60m**

sensor

- ✓ plastic housing Ø10mm
- ✓ metal sleeve nickel-plated brass or stainless steel M12x1mm
- ✓ aluminium housing 12x12mm
- ✓ connection to amplifier
- ✓ threaded devices to Euronorm
- ✓ large sensing ranges

amplifier

- ✓ relay or short-circuit protected semiconductor relay
- ✓ alignment mark via test function
- ✓ test input for disabling the transmitter
- ✓ alarm output for soiling display
- ✓ up to 4-way selectable transmitting frequency
- ✓ 0 to 10sec turn-on and turn-off delay
- ✓ 2-way selectable dominant output
- ✓ selectable light-on / dark-on mode
- ✓ automatic self-test

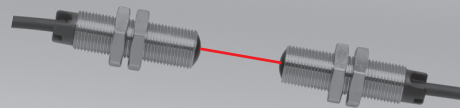
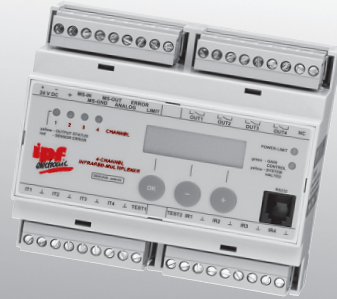

**operating distance up to 60m
depending on through-beam sensor type**

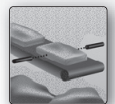
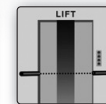
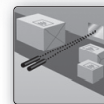
description

The high-performance through-beam sensor systems have been engineered specifically for applications where conventional light barriers have reached their limits. They excel in their extreme insensitivity to soiling and in their sensing range and are ideally suited to difficult applications, where up till now only compromise solutions have existed. Thanks to the high performance of the systems, significant penetration is ensured even under conditions of heavy soiling. Chips, dust, flour, oil or dirty water no longer present any obstacle. They are thus perfectly suited for applications in the wood and paper industry, for car-washes, for the control of bulk materials, in elevators, for door

controls out in the open, in the food processing industry, etc. Each system comprises one sensor, one receiver and one amplifier. The transmitters and receivers, in various very compact robust designs, can be accommodated in any construction.

Their large angle of beam spread facilitates their alignment with each other even for sensing ranges of 35m. At the same time they are insensitive to vibration, shock and a resulting loss of alignment.

The high level of user-friendliness is underlined by the ease of installation of the amplifier and sensors as well as by the uncomplicated operation of the devices.

The OV6x series is a further development of the tried and tested amplifiers in the OV58 and OV59 series. Cased in modern housings with a top hat rail installation, the processor controlled devices work with modulated infrared light, thus allowing a high level of security against external light. The circuit / connection is configured in such a way that only signals with the correct frequency and phase position are recognized.

alarm display

see alarm output

alarm output "alarm" and/or "limit"

A signal is transmitted before the output limit is reached. The red LED on the amplifier lights up at the same time. The system nevertheless continues to be fully functional.

analog output

The analog output helps with the alignment of the sensors and provides a voltage of 0 ... 10V DC, which is proportional to the signal received.

automatic mode

The automatic amplifiers represent a logical further development of the light barrier amplifiers. The amplifiers automatically adapt the transmitting power to the prevailing environmental conditions, permanently compensating 100% for any effects on the system resulting from interference. The switching point is constant over the full power band width and reproducible.

error output

see permanent sensor monitoring

dominant output

Some devices have selectable output ranges.

intensity display

The green intensity display is permanently lit whenever the transmitting power is sufficient. If the display flashes or goes out completely, then either the transmitting power has been set too low, the transmitter and/or receiver lenses are too soiled for the set transmitting power, the distance between transmitter and receiver is too great or the transmitter and receiver have been incorrectly adjusted out of tolerance.

light curtain (only OV64 and OV65)

Only one relay or transistor output will react in the case that one of the light barriers is interrupted.

manual operation

Using the control the user can set the transmitting power to the desired degree. Any change of the environmental conditions requires a readjustment.

master-slave operation

The number of light barriers can be increased even further by connecting multiplexers in series.

permanent sensor monitoring

This device signals any sensor error cropping up during the operation (short-circuit or interruption) by the lighting up of LEDs with specification of the error and sensor type. On some versions an additional error output will become active.

Apart from 1-channel amplifiers, devices are also realized with 2, 4 or 8 channels. These work using the multiplex technique. In the versions that have many features, the transmitting power is set by toggling. This is also done automatically. An optionally available PC software for the 4 and 8 channel versions allows convenient operation.

control system display

The green control system display is permanently lit while the automatic transmitting setting is active. Whenever it goes out the control has been stopped.

relay output (only OV63)

The relay output, executed as a make contact or a changeover contact, comes in a floating version that reacts to any interruption of the light barrier.

switching output

The switching output, a short-circuit protected semi-conductor relay (contact), reacts to the breaking of the through-beam sensor.

switching reaction (OV634915, OV64 and OV65)

A choice can be made between a permanently (delayed) reaction to the breaking of the through-beam sensor or one which is pulse-like with a settable pulse length of 0...10sec.

switching function

The switching function describes the behavior of the switching output during an interruption of the infrared beam. In the dark-on mode "dark" an output signal is generated if the light beam is interrupted. In the light on mode "light" it is generated if the light beam is uninterrupted.

switching delay

The turn-on delay or turn-off delay delays the reaction of the relay output by a time that is adjustable between 0...10sec.

status display

The yellow switching status display lights up when the switching output or the relay output is active.

transmitting frequency

The transmitting frequency is the frequency with which the amplifier transmits. Some versions can be operated with different frequencies.

transmitter and receiver connections

All transmitter and receiver connections of the amplifiers have short-circuit protection. Even in case of an unintentional short-circuit it is impossible to damage the inputs.

test input

To test the functionality of the system, it is possible for example to switch off the transmitter using a PLC, in order to test if a status change is taking place on the relay or on the transistor output of this amplifier.

test function

The amplifier signals the user whether or not an error has cropped up on the transmitter or the receiver side. For any non-existence of an error the test function will display the quality of the passing. A LED has been provided for the display, which can flash 1 to 10 times with the flashing being proportional to the signal that is received.

through-beam sensors, amplifiers 3100

- ✓ up to 55m operating distance
- ✓ sensitivity adjustable with rotary knob
- ✓ switching output 60V / 100mA – short-circuit protection
- ✓ test input for disabling the transmitter

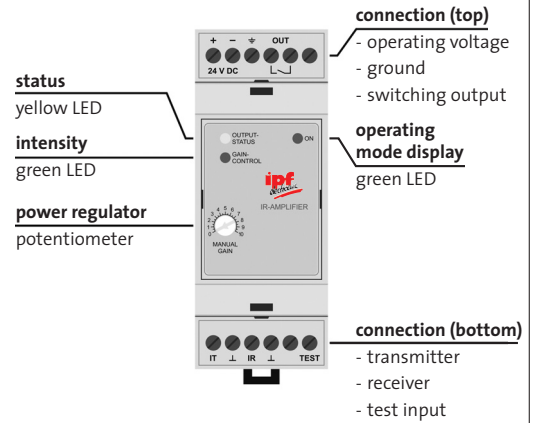

TECHNICAL DATA

1 channel amplifier, relay output

article-no.	OV620880
operating voltage	24V DC / ±20% / 2.4W
measuring system	pulsed infrared light: 3.9kHz
transmitting power	manual
switching function	light-on mode
dominant output	high
switching delay	-
switching output	1 normally open contact: 60V DC (AC) / 100mA
reaction time	24msec
alarm output	-
analog output	-
test input	0 ... 30V DC
operating distance (stand./incr./max.)	15/25/55m (7/10/20m for OE126303)
housing material	noryl
system of protection (EN 60529)	IP 20
operating temperature	-25 ... +50°C
connection	pluggable screw terminals
transmitter and receiver / accessories	see page 34 to 38

dimensional drawing

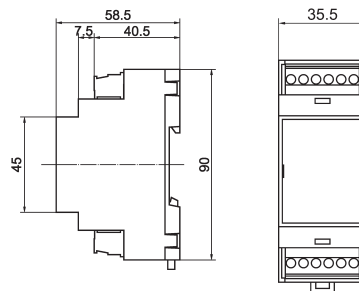

connection

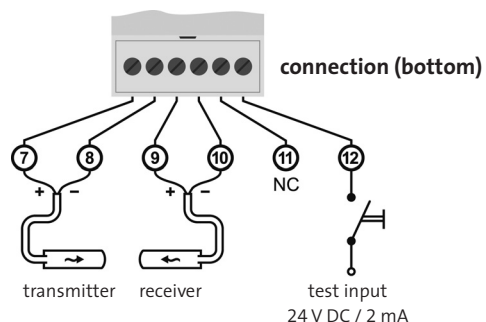
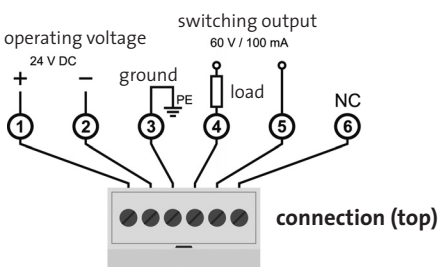

- ✓ up to 55m operating distance
- ✓ 4-way selectable transmitting frequency
- ✓ sensitivity adjustable with rotary knob
- ✓ dominant output high / low selectable
- ✓ switching output 60V / 100mA – short-circuit protection
- ✓ selectable light-on / dark-on mode
- ✓ alarm output for power limit
- ✓ test input for disabling the transmitter

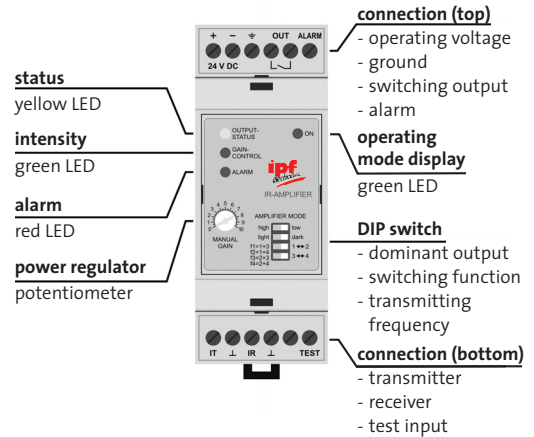

TECHNICAL DATA	1 channel amplifier, relay output, alarm output
article-no.	OV620800
operating voltage	24V DC / ±20% / 2.4W
measuring system	pulsed infrared light: 3.5 / 3.8 / 4.0 / 4.5kHz
transmitting power	manual
switching function	light-on / dark-on mode
dominant output	low / high
switching delay	-
switching output	1 normally open contact: 60V DC (AC) / 100mA
reaction time	24msec
alarm output	pnp, 24V DC, 100mA
analog output	-
test input	0 ... 30V DC
operating distance (stand./incr./max.)	15/25/55m (7/10/20m for OE126303)
housing material	noryl
system of protection (EN 60529)	IP 20
operating temperature	-25 ... +50°C
connection	pluggable screw terminals
transmitter and receiver / accessories	see page 34 to 38

DIP switch position

1	dominant output	high	low
2	switching function	light	dark
3	transmitting frequency	3.5kHz	3.8kHz
4		4.0kHz	4.5kHz

Manufacturer's settings highlighted grey.

dimensional drawing

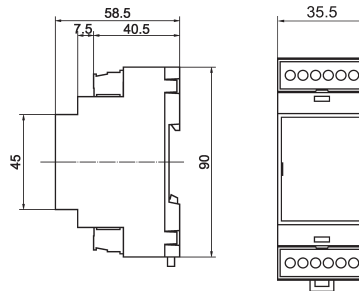

connection

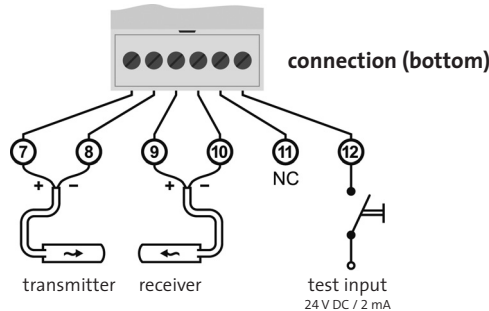
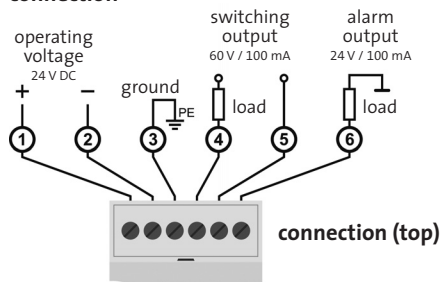

through-beam sensors, amplifiers 3100

- ✓ up to 55m operating distance
- ✓ 2-way selectable transmitting frequency
- ✓ selectable manual / automatic operation
- ✓ dominant output high / low selectable
- ✓ switching output 60V / 100mA – short-circuit protection
- ✓ selectable light-on / dark-on mode
- ✓ analog output for testing and alignment
- ✓ alarm output for power limit
- ✓ test input for disabling the transmitter
- ✓ automatic self-test
- ✓ permanent sensor monitoring

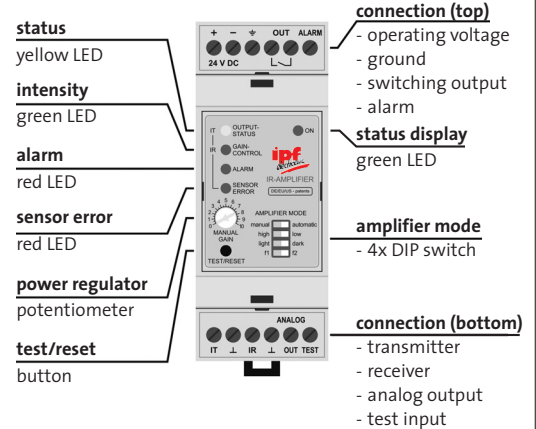

TECHNICAL DATA

1 channel amplifier, relay output, alarm output, analog output

article-no.	OV620810
operating voltage	24V DC / ±20% / 2.4W
measuring system	pulsed infrared light: 3.7 / 4.3kHz
transmitting power	manual / automatic
switching function	light-on / dark-on mode
dominant output	low / high
switching delay	-
switching output	1 normally open contact: 60V DC (AC) / 100mA
reaction time	24msec
alarm output	pnp, 24V DC, 100mA
analog output	0 ... 10V DC
test input	0 ... 30V DC
operating distance (stand./incr./max.)	15/25/55m (7/10/20m for OE126303)
housing material	noryl
system of protection (EN 60529)	IP 20
operating temperature	-25 ... +50°C
connection	pluggable screw terminals
transmitter and receiver / accessories	see page 34 to 38

DIP switch position

1	operational mode	manual	manual
2	dominant output	high	low
3	switching function	light	dark
4	transmitting frequency	3.7kHz	4.3kHz

Manufacturer's settings highlighted grey.

dimensional drawing

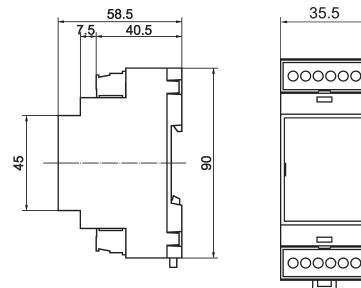

connection

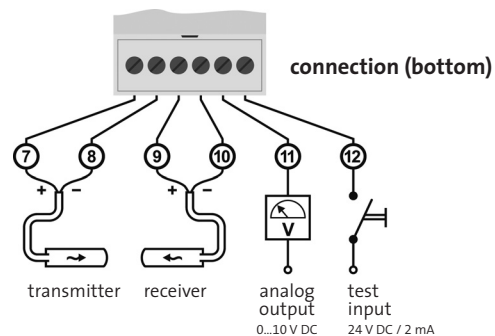
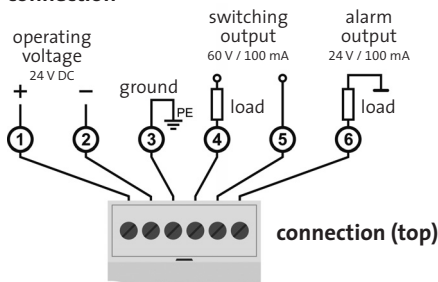

- ✓ up to 50m operating distance
- ✓ 2-way selectable transmitting frequency
- ✓ selectable manual / automatic operation
- ✓ dominant output high / low selectable
- ✓ relay output 1 change-over contact
- ✓ selectable light-on / dark-on mode
- ✓ turn-on and/or turn-off delay or pulsed switching reaction of the relay
- ✓ alarm output for power limit
- ✓ test input for disabling the transmitter
- ✓ automatic self-test
- ✓ permanent sensor monitoring

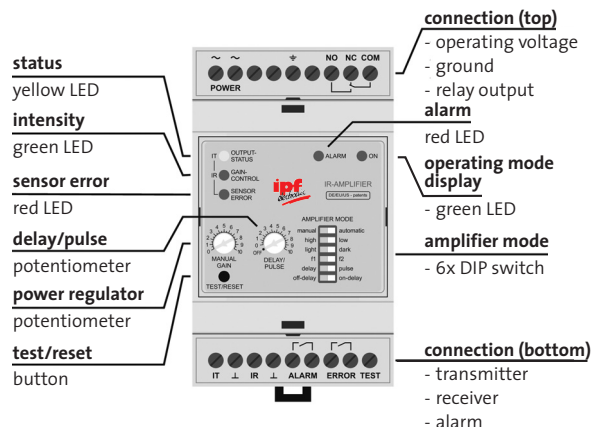

TECHNICAL DATA

1 channel amplifier, relay output, alarm output, time delay

article-no.	OV634915
operating voltage	230V AC / ±10% / 4.8VA
measuring system	pulsed infrared light: 3.7 / 4.3kHz
transmitting power	manual / automatic
switching function	light-on / dark-on mode
dominant output	low / high
switching delay	0 ... 10sec
switching output	1 change-over contact: 5A / 230V AC (24V DC)
sampling frequency	20Hz (low), 11Hz (high)
alarm output	1 normal open contact: 60V AC (DC) / 100mA
analog output	-
test input	0 ... 30V DC
operating distance (stand./incr./max.)	15/20/50m (8/10/20m for OE126303)
housing material	noryl
system of protection (EN 60529)	IP 20
operating temperature	-25 ... +50°C
connection	pluggable screw terminals
transmitter and receiver / accessories	see page 34 to 38

DIP switch position

	operational mode	manual	automatic
1		<input type="checkbox"/>	<input type="checkbox"/>
2	dominant output	high <input type="checkbox"/>	low <input type="checkbox"/>
3	switching function	light <input type="checkbox"/>	dark <input type="checkbox"/>
4	transmitting frequency	3.7kHz <input type="checkbox"/>	4.3kHz <input type="checkbox"/>
5	switching reaction mode	delay <input type="checkbox"/>	pulse <input type="checkbox"/>
6	switching delay	off-delay <input type="checkbox"/>	on-delay <input type="checkbox"/>

Manufacturer's settings highlighted grey.

dimensional drawing

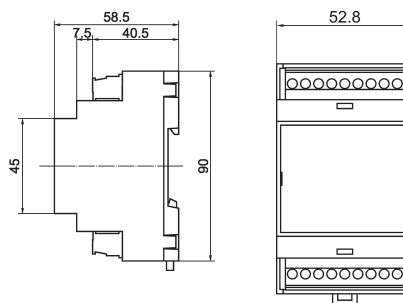

connection

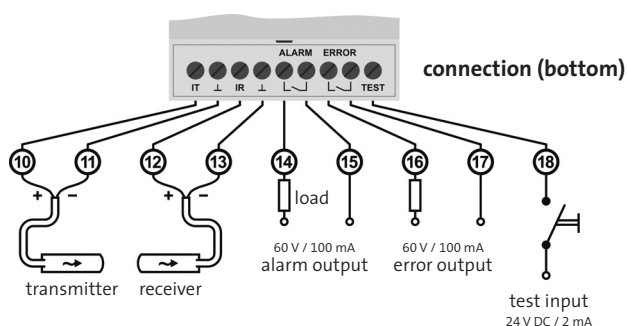
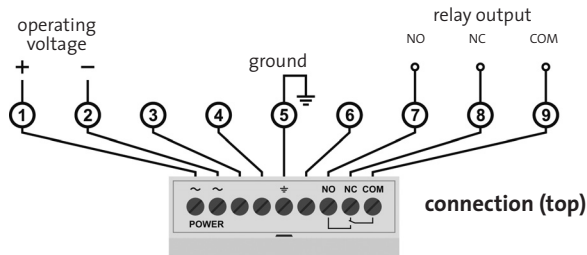

through-beam sensors, amplifiers 3100

- ✓ up to 55m operating distance
- ✓ selectable manual / automatic operation
- ✓ dominant output high / low selectable
- ✓ switching output 60V / 100mA – short-circuit protection
- ✓ selectable light-on / dark-on mode
- ✓ alarm output for power limit
- ✓ test input for disabling the transmitter
- ✓ automatic self-test
- ✓ permanent sensor monitoring

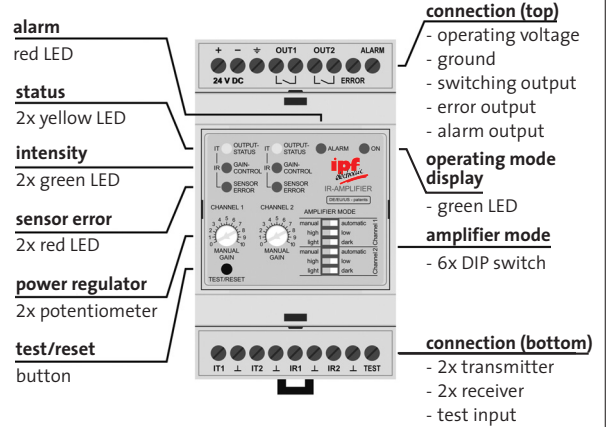

TECHNICAL DATA

2 channel multiplexer, relay output, alarm output

article-no.	OV630840
operating voltage	24V DC / ±20% / 3.6W
measuring system	pulsed infrared light: 3.9kHz
multiplex speed	8msec
transmitting power	manual / automatic
switching function	light-on / dark-on mode
dominant output	low / high
switching delay	-
switching output	2 normally open contacts: 60V DC (AC) / 100mA
reaction time	24msec
alarm output	pnp, 24V DC, 100mA
analog output	-
test input	0 ... 30V DC
operating distance (stand./incr./max.)	20/30/55m (8/10/20m for OE126303)
housing material	noryl
system of protection (EN 60529)	IP 20
operating temperature	-25 ... +50°C
connection	pluggable screw terminals
transmitter and receiver / accessories	see page 34 to 38

DIP switch position

1	operational mode channel 1	manual	automatic
2	dominant output channel 1	high	low
3	switching function channel 1	light	dark
4	operational mode channel 2	3.7kHz	automatic
5	dominant output channel 2	delay	low
6	switching function	off-delay	dark

Manufacturer's settings highlighted grey.

dimensional drawing

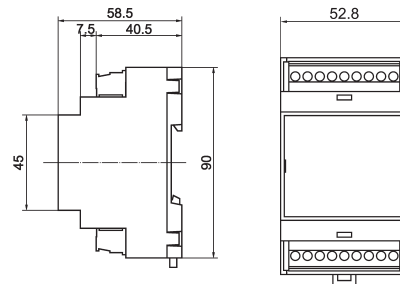

connection

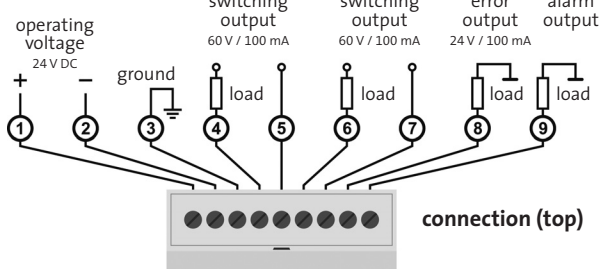

connection (bottom)

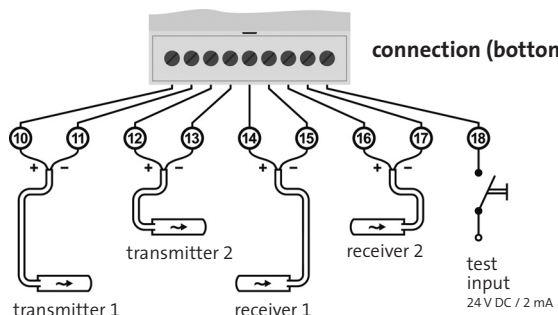

- ✓ up to 60m operating distance
- ✓ menu-driven operation via display
- ✓ selectable manual / automatic operation
- ✓ dominant output high / low selectable
- ✓ switching output 60V / 100mA – short-circuit protection
- ✓ selectable light-on / dark-on mode
- ✓ turn-on and turn-off delay 0 ... 10sec
- ✓ alarm output
- ✓ test input for disabling the transmitter
- ✓ automatic self-test
- ✓ analog output
- ✓ permanent sensor monitoring
- ✓ operation via PC-software (accessories)

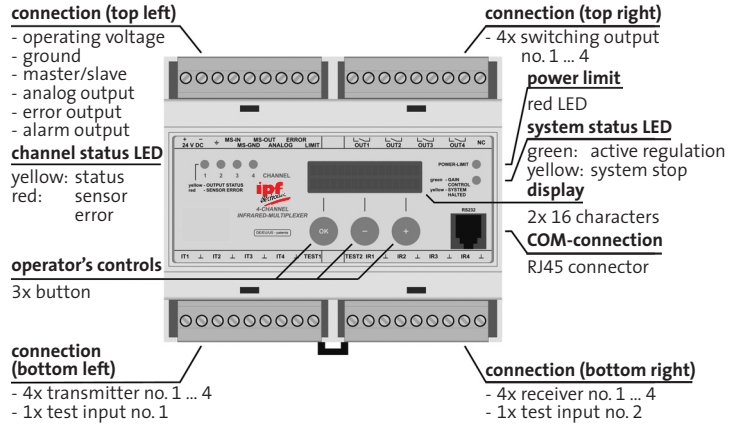

TECHNICAL DATA

4 channel multiplexer, relay output, analog output, alarm output

article-no.	OV640840
operating voltage	24V DC / ±20% / 6.5W
measuring system	pulsed infrared light: 4kHz
multiplex speed	18msec
transmitting power	manual / automatic
switching function	light-on / dark-on mode
dominant output	low / high
switching delay	0 ... 10sec
switching output	4 normally open contacts: 60V DC (AC) / 100mA
reaction time	20msec
alarm output	pnp, 24V DC, 100mA
analog output	0 ... 10V DC
test input	0 ... 30V DC
COM interface	RS 232
operating distance (stand./incr./max.)	15/25/60m (10/12/25m for OE126303)
housing material	noryl
system of protection (EN 60529)	IP 20
operating temperature	0 ... +50°C
connection	pluggable screw terminals
transmitter and receiver / accessories	see page 34 to 38
RS232-cable including software	AO000098

dimensional drawing

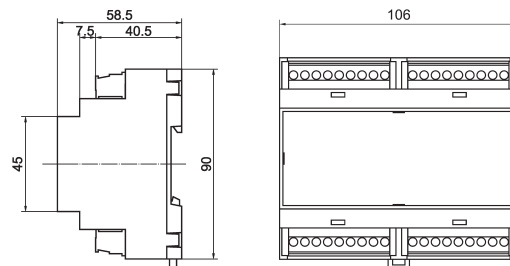

connection

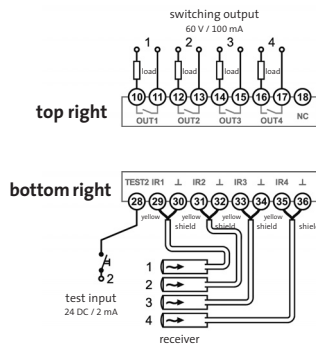
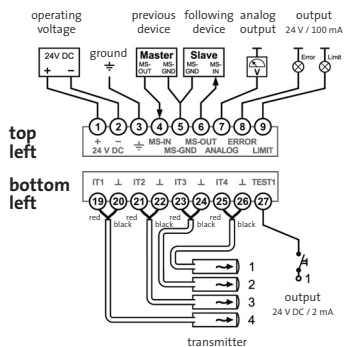

through-beam sensors, amplifiers 3100

- ✓ up to 60m operating distance
- ✓ menu-driven operation via display
- ✓ selectable manual / automatic operation
- ✓ dominant output high / low selectable
- ✓ switching output 60V / 100mA – short-circuit protection
- ✓ selectable light-on / dark-on mode
- ✓ turn-on and turn-off delay 0 ... 10sec
- ✓ alarm output
- ✓ test input for disabling the transmitter
- ✓ automatic self-test
- ✓ analog output
- ✓ permanent sensor monitoring
- ✓ operation via PC-software (accessories)

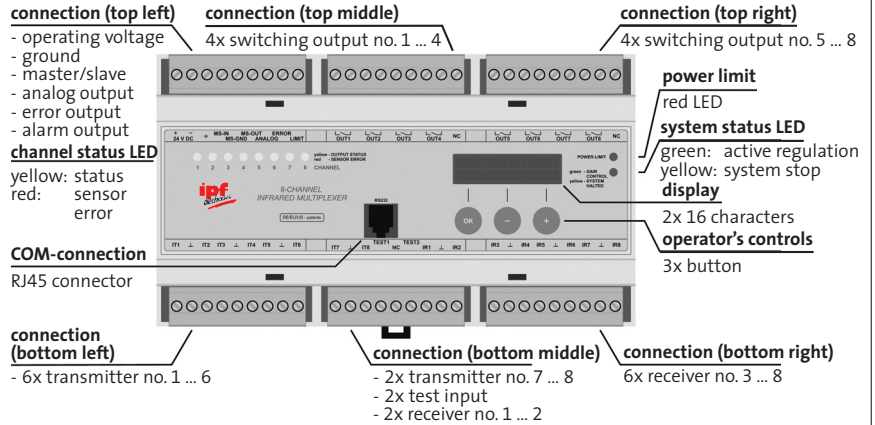

TECHNICAL DATA

4 channel multiplexer, relay output, analog output, alarm output

article-no.	OV650840
operating voltage	24V DC / ±20% / 8.5VA
measuring system	pulsed infrared light: 4kHz
multiplex speed	34msec
transmitting power	manual / automatic
switching function	light-on / dark-on mode
dominant output	low / high
switching delay	0 ... 10sec
switching output	8 normally open contacts: 60V DC (AC) / 100mA
reaction time	36msec
alarm output	pnp, 24V DC, 100mA
analog output	0 ... 10V DC
test input	0 ... 30V DC
COM interface	RS 232
operating distance (stand./incr./max.)	15/25/60m (10/12/25m for OE126303)
housing material	noryl
system of protection (EN 60529)	IP 20
operating temperature	0 ... +50°C
connection	pluggable screw terminals
transmitter and receiver / accessories	see page 34 to 38
RS232-cable including software	AO00098

dimensional drawing

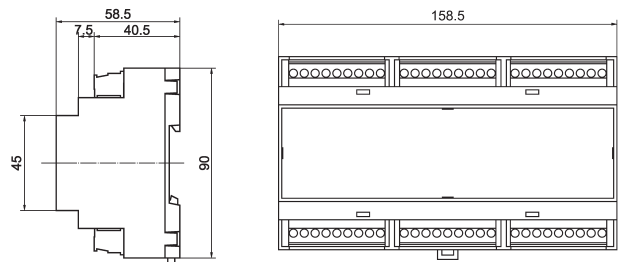

connection

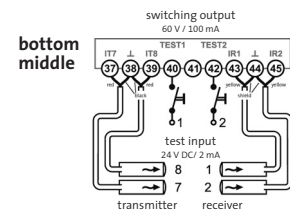
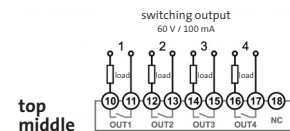
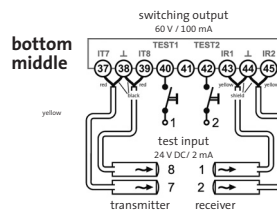
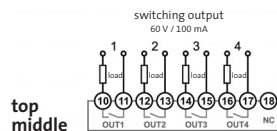
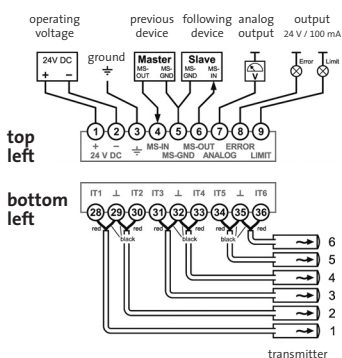

notes

export division

Kalver Straße 27
D-58515 Lüdenscheid

Fon +49 (0) 2351 / 98597-0
Fax +49 (0) 2351 / 98597-29



design **100 x 75 x 110mm**
 up to
149 x 75 x 110mm

through-beam sensor operating distance **up to 70m**

sensor

- ✓ plastic housing Ø10mm
- ✓ metal sleeve nickel-plated brass or stainless steel M12x1mm
- ✓ aluminium housing 12x12mm
- ✓ connection to amplifier
- ✓ threaded devices to Euronorm
- ✓ large sensing ranges

amplifier

- ✓ relay or transistor switching output
- ✓ alignment mark via test function
- ✓ teach input
- ✓ test input for disabling the transmitter
- ✓ alarm output for soiling display
- ✓ up to 4-way selectable transmitting frequency
- ✓ turn-on and turn-off delay 0 ... 10sec
- ✓ up to 4-way selectable dominant output
- ✓ selectable light-on / dark-on mode
- ✓ automatic self-test
- ✓ plug-in base connection

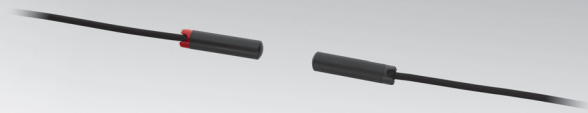
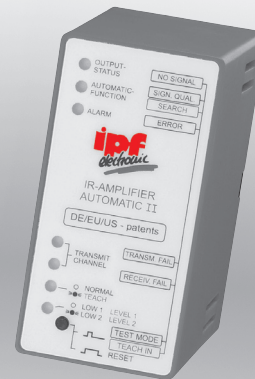

**up to 70m operating distance
 depending on through-beam sensor type**

description

The high-performance through-beam sensor systems have been engineered specifically for applications where conventional light barriers have reached their limits. They excel in their extreme insensitivity to soiling and in their sensing range and are ideally suited to difficult applications, where up till now only compromise solutions have existed. Thanks to the high performance of the systems, significant penetration is ensured even under conditions of heavy soiling. Chips, dust, flour, oil or dirty water no longer present any obstacle. They are thus perfectly suited for applications in the wood and paper industry, for car-washes, for the control of bulk materials, in elevators, for door

controls out in the open, in the food processing industry, etc. Each system comprises one sensor, one receiver and one amplifier. The transmitters and receivers, in various very compact robust designs, can be accommodated in any construction.

Their large angle of beam spread facilitates their alignment with each other even for sensing ranges of 35m. At the same time they are insensitive to vibration, shock and a resulting loss of alignment.

The high level of user-friendliness is underlined by the ease of installation of the amplifier and sensors as well as by the uncomplicated operation of the devices.

The amplifiers operate with modulated infrared light that provides high external light shielding. The circuit has been laid out in a way that signals with the correct frequency and phase position will be the only ones recognized. This excludes any interference from other light barriers to the greatest extent.

alarm display

The red alarm display is permanently lit while the light passing stays uninterrupted and when the intensity display has been turned off for a few seconds. With automatic amplifiers it is turned on, if the transmitting power is at least 95% of the maximum transmitting power.

alarm output

A signal is transmitted before the output limit is reached. The red LED on the amplifier lights up at the same time. The system nevertheless continues to be fully functional.

analog output

The analog output helps with the alignment of the sensors and provides a voltage of 0 ... 10V DC, which is proportional to the signal received.

turn-off delay

The turn-off delay is the period between release (light-on mode) or interruption (dark-on mode) of the infrared beam and the switchover of the switching output.

automatic mode

The amplifiers automatically adapt the transmitting power to the prevailing environmental conditions, permanently compensating 100% for any effects on the system resulting from interference. The switching point is constant over the full power band width and reproducible.

turn-on delay

The turn-on delay is the time period between interruption (light-on mode) or release (dark-on mode) of the infrared beam and the switchover of the switching output.

dominant output

Some devices have selectable output ranges.

intensity display

The green intensity display is permanently lit whenever the transmitting power is sufficient. If the display flashes or goes out completely, then either the transmitting power has been set too low, the transmitter and/or receiver lenses are too soiled for the set transmitting power, the distance between transmitter and receiver is too great or the transmitter and receiver have been incorrectly adjusted out of tolerance.

manual operation

Using the control the user can set the transmitting power to the desired degree. Any change of the environmental conditions requires a readjustment.

permanent sensor monitoring

This device signals any sensor error cropping up during the operation (short-circuit or interruption) by the lighting up of LEDs with specification of the error and sensor type. On some versions an additional error output will become active.

For applications where several light barriers of the same type are to be operated side by side there are versions with adjustable transmitting frequency. In addition to amplifiers with manual setting of the transmitting power, we also offer processor-controlled versions with automatic control.

control system display

The green control system display is permanently lit while the automatic transmitting setting is active. Whenever it goes out the control has been stopped.

relay output

The relay output (change-over contact) comes in a floating version.

switching function

The switching function describes the behavior of the switching output in case of the infrared beam has been interrupted. In the dark-on mode "dark" an output signal is generated if the light beam is interrupted. In the light-on mode "light" no output signal is generated if the light beam is interrupted.

status display

The yellow switching status display lights up when the switching output is active.

transmitting frequency

The transmitting frequency is that frequency with which the light of the transmitter has been clocked.

transmitter and receiver connections

All transmitter and receiver connections of the amplifiers have short-circuit protection. Even in case of an unintentional short-circuit it is impossible to damage the device.

teach function

The teach function allows the user a programming of the switching output turn-off point. The object to be recognized must be placed between the sensors and the teach-in function is activated by pressing the button. The amplifier sets the switch-point in a way that the object is recognized. A transparent object, however, will not be recognized.

test input

To test the functionality of the system, it is possible for example to switch off the transmitter using a PLC, in order to test if a status change is taking place on the relay or on the transistor output of this amplifier.

test function

Some of the automatic devices have a sensor monitoring function included to recognize functional errors or defects on the sensors. These can be activated by pushing the button of the test function. The amplifier signals the user whether or not an error is present with the transmitter or the receiver. For any non-existence of an error the test function will display the quality of the path. An LED has been provided for the display, which can flash 1 to 10 times with the flashing being proportional to the signal that is received.

transistor output

These outputs can be used as NPN output or PNP output depending on the external switching.

through-beam sensors, amplifiers 3100

- ✓ up to 70m operating distance
- ✓ sensitivity adjustable with rotary knob
- ✓ relay output

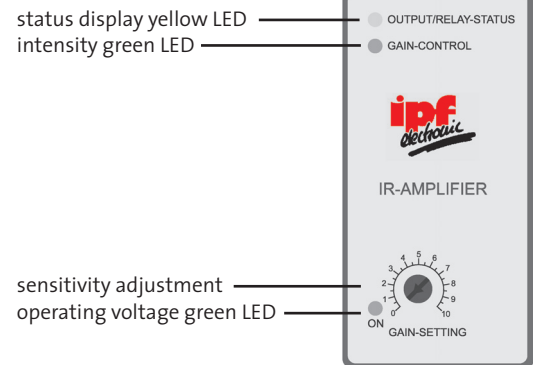

TECHNICAL DATA

1 channel amplifier, relay output

article-no.	OV580980 (DC device)
article-no.	OV584980 (AC device)
operating voltage	24V DC / ±20% / 1.9W
operating voltage	230V AC / ±10% / 3.8VA
relay output	1 change-over contact: 5A / 230V AC (24V DC)
sampling frequency	18Hz
alarm output	-
measuring system	pulsed infrared light: 3.5kHz
transmitting power	-
operating distance (stand./incr./max.)	25/35/70m (20/30/50m for OE126303)
dominant output	100%
teach input	-
switching delay	-
switching function	light-on mode
test input	-
housing material	plastic
system of protection (EN 60529)	IP 40
operating temperature	-25 ... +50°C
connection	pluggable into 11-pin socket
transmitter and receiver / accessories	see page 34 to 38

dimensional drawing

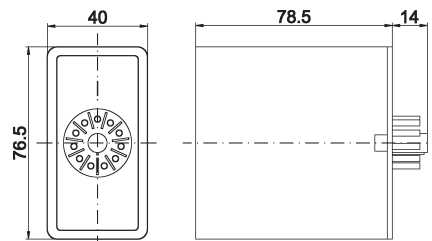

connection

operating voltage

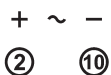

relay

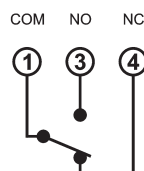

transmitter

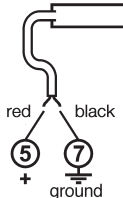

receiver

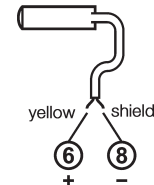

3100 through-beam sensors, amplifiers



- ✓ up to 70m operating distance
- ✓ sensitivity adjustable with rotary knob
- ✓ relay output
- ✓ transistor output pnp / npn
- ✓ test input
- ✓ 4-way selectable transmitting frequency
- ✓ 20% / 100% selectable dominant output
- ✓ selectable light-on / dark-on mode

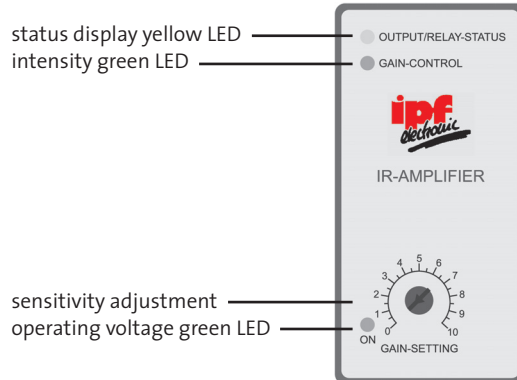

TECHNICAL DATA

1 channel amplifier, relay output, transistor output

article-no.	OV580900 (DC device)
article-no.	OV584900 (AC device)
operating voltage	24V DC / ±20% / 2.0W
operating voltage	230V AC / ±10% / 4.2VA
relay output	1 change-over contact: 5A / 230V AC (24V DC)
sampling frequency (relay)	18Hz
transistor output (AC device)	npn: 0.1A (30V DC) / pnp: 5mA (12V DC)
transistor output (DC device)	npn / pnp: 0.1A (30V DC)
sampling frequency (transistor)	30Hz
alarm output	-
measuring system	pulsed infrared light: 3.5 / 3.8 / 4.0/ 4.4kHz
transmitting power	-
operating distance (stand./incr./max.)	25/35/70m (20/30/50m for OE126303)
dominant output	20% / 100%
teach input	-
switching delay	-
switching function	light-on / dark-on mode
test input	24V DC
housing material	plastic
system of protection (EN 60529)	IP 40
operating temperature	-25 ... +50°C
connection	pluggable into 11-pin socket
transmitter and receiver / accessories	see page 34 to 38

DIP switch position



1		2		3		4	
dominant output		switching function		transmitting frequency			
20 %	ON	dark	ON	3.5 kHz	ON	ON	
				3.8 kHz	ON	OFF	
100 %	OFF	light	OFF	4.0 kHz	OFF	ON	
				4.4 kHz	OFF	OFF	

Manufacturer's settings highlighted grey.

dimensional drawing

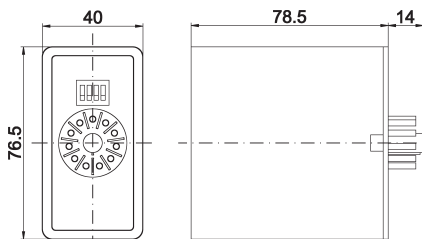

connection

operating voltage

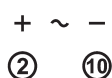

relay

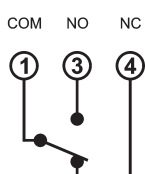

transmitter

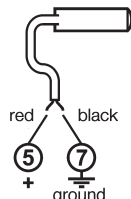

receiver

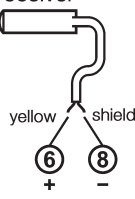

transistor output

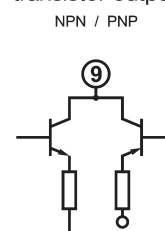

test input



through-beam sensors, amplifiers 3100

- ✓ up to 70m operating distance
- ✓ sensitivity adjustable with rotary knob
- ✓ relay output
- ✓ transistor output pnp / npn
- ✓ turn-on / turn-off delay
- ✓ test input
- ✓ 4-way selectable transmitting frequency
- ✓ 20% / 100% selectable dominant output
- ✓ selectable light-on / dark-on mode

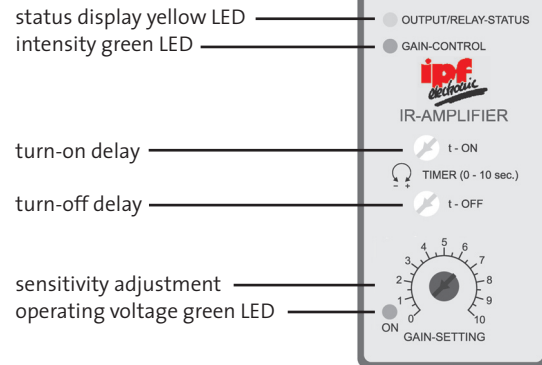

TECHNICAL DATA

1 channel amplifier, relay output, transistor output, time delay

article-no.	OV580905 (DC device)
article-no.	OV584905 (AC device)
operating voltage	24V DC / ±20% / 2.0W
operating voltage	230V AC / ±10% / 4.2VA
relay output	1 change-over contact: 5A / 230V AC (24V DC)
sampling frequency (relay)	12Hz
transistor output (AC device)	npn: 0.1A (30V DC) / pnp: 5mA (12V DC)
transistor output (DC device)	npn / pnp: 0.1A (30V DC)
sampling frequency (transistor)	20Hz
alarm output	-
measuring system	pulsed infrared light: 3.5 / 3.8 / 4.0 / 4.4kHz
transmitting power	-
operating distance (stand./incr./max.)	25/35/70m (20/30/50m for OE126303)
dominant output	20% / 100%
teach input	-
switching delay	0 ... 10sec
switching function	light-on / dark-on mode
test input	24V DC
housing material	plastic
system of protection (EN 60529)	IP 40
operating temperature	-25 ... +50°C
connection	pluggable into 11-pin socket
transmitter and receiver / accessories	see page 34 to 38

DIP switch position



1		2		3		4	
dominant output		switching function		transmitting frequency			
20 %	ON	dark	ON	3.5 kHz	ON	ON	
				3.8 kHz	ON	OFF	
100 %	OFF	light	OFF	4.0 kHz	OFF	ON	
				4.4 kHz	OFF	OFF	

Manufacturer's settings highlighted grey.

dimensional drawing

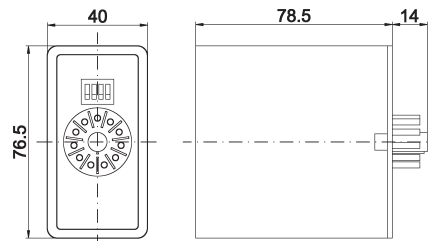

connection

operating voltage

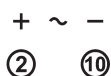

relay

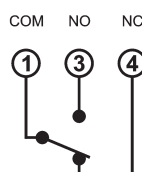

transmitter

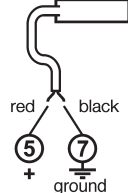

receiver

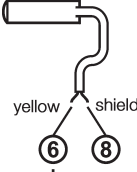

transistor output

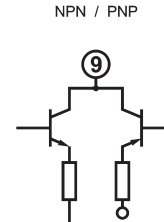

test input



- ✓ up to 70m operating distance
- ✓ sensitivity adjustable with rotary knob
- ✓ relay output
- ✓ transistor output pnp / npn
- ✓ turn-on / turn-off delay
- ✓ alarm output for soiling display
- ✓ 4-way selectable transmitting frequency
- ✓ 20% / 100% selectable dominant output
- ✓ selectable light-on / dark-on mode

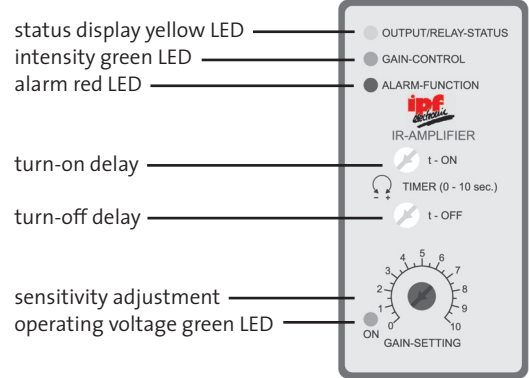

TECHNICAL DATA	1 channel amplifier, relay output, transistor output, alarm output, time delay
article-no.	OV580907
operating voltage	24V DC / ±20% / 2.0W
relay output	1 change-over contact: 5A / 230V AC (24V DC)
sampling frequency (relay)	12Hz
transistor output	npn / pnp: 0.1A (30V DC)
sampling frequency (transistor)	20Hz
alarm output	npn / pnp: 0.1A (30V DC)
measuring system	pulsed infrared light: 3.5 / 3.8 / 4.0/ 4.4kHz
transmitting power	-
operating distance (stand./incr./max.)	25/35/70m (20/30/50m for OE126303)
dominant output	20% / 100%
teach input	-
switching delay	0 ... 10sec
switching function	light-on / dark-on mode
test input	-
housing material	plastic
system of protection (EN 60529)	IP 40
operating temperature	-25 ... +50°C
connection	pluggable into 11-pin socket
transmitter and receiver / accessories	see page 34 to 38

DIP switch position



1		2		3		4	
dominant output		switching function		transmitting frequency			
20 %	ON	dark	ON	3.5 kHz	ON	ON	
				3.8 kHz	ON	OFF	
100 %	OFF	light	OFF	4.0 kHz	OFF	ON	
				4.4 kHz	OFF	OFF	

Manufacturer's settings highlighted grey.

dimensional drawing

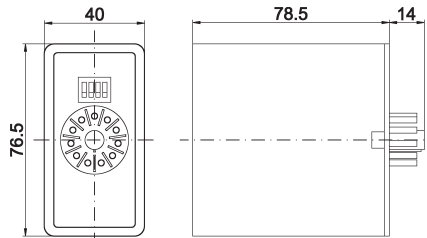

connection

operating voltage

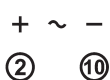

relay

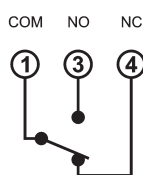

transmitter

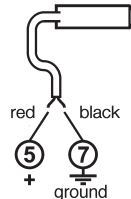

receiver

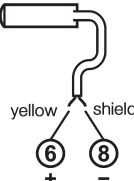

transistor output

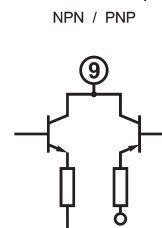

alarm output

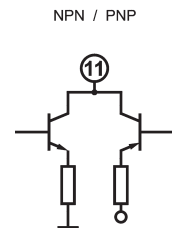

through-beam sensors, amplifiers 3100

- ✓ up to 50m operating distance
- ✓ transistor switching output pnp / npn
- ✓ relay output
- ✓ alignment mark via test function
- ✓ test input for disabling the transmitter
- ✓ alarm output for soiling display
- ✓ 2-way selectable transmitting frequency
- ✓ 4-way selectable dominant output
- ✓ selectable light-on / dark-on mode
- ✓ automatic self-test
- ✓ plug-in base connection

status display yellow LED
 regulation green LED
 alarm red LED

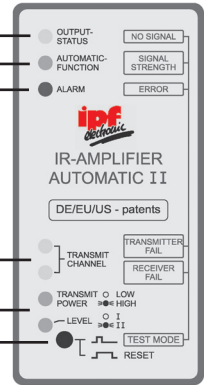

transmitting frequency 2x yellow LED
 dominant output 2x green LED
 test / reset button

TECHNICAL DATA

1 channel automatic amplifier, relay output, transistor output, alarm output

article-no.	OV580510 (DC device)	OV580910 (DC device)
article-no.	OV584510 (AC device)	OV584910 (AC device)
operating voltage	24V DC / ±20% / 2.2W	24V DC / ±20% / 2.2W
operating voltage	230V AC / ±10% / 4.8VA	230V AC / ±10% / 4.8VA
transistor output	npn / pnp, max 30V DC / 100mA	-
sampling frequency (transistor)	low: 20Hz / high: 11Hz	-
relay output	-	1 change-over contact: 5A / 230V AC (24V DC)
sampling frequency (relay)	-	low: 20Hz / high: 11Hz
alarm output	pnp, 24V DC, DC:100mA, AC: 5mA	pnp, 24V DC, DC:100mA, AC: 5mA
measuring system	pulsed infrared light: 3.7 / 4.1kHz	pulsed infrared light: 3.7 / 4.1kHz
transmitting power	automatic	automatic
operating distance (stand./incr./max.)	15/25/50m (7/10/20m for OE126303)	15/25/50m (7/10/20m for OE126303)
dominant output	low 1 / low 2 / high 1 / high 2	low 1 / low 2 / high 1 / high 2
teach input	-	-
switching delay	-	-
switching function	light-on / dark-on mode (no / nc) selectable	light-on / dark-on mode (no / nc) selectable
test input	0 ... 30V DC	0 ... 30V DC
housing material	plastic	plastic
system of protection (EN 60529)	IP 40	IP 40
operating temperature	-25 ... +50°C	-25 ... +50°C
connection	pluggable into 11-pin socket	pluggable into 11-pin socket
transmitter and receiver / accessories	see page 34 to 38	see page 34 to 38

DIP switch position



	1	2	3		4	
dominant output	switching function		transm. frequency			
high 2	ON	ON	dark	ON	4,1 kHz	ON
high 1	ON	OFF	light	OFF	3,7 kHz	OFF
low 2	OFF	ON				
low 1	OFF	OFF				

Manufacturer's settings highlighted grey.

dimensional drawing

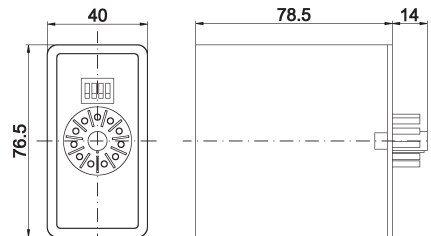

connection

operating voltage

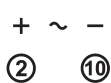

transistor output

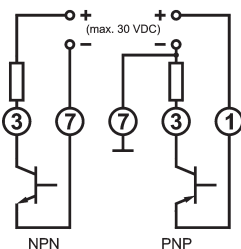

relay

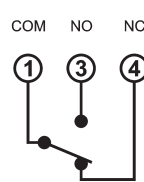

transmitter

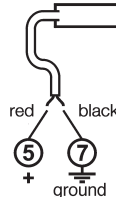

receiver

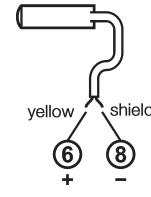

alarm output

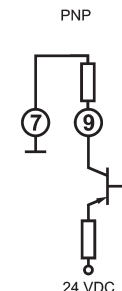

test input

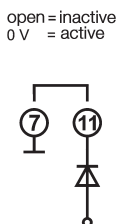

- ✓ up to 50m operating distance
- ✓ transistor switching output pnp / npn
- ✓ relay output
- ✓ alignment mark via test function
- ✓ test input for disabling the transmitter
- ✓ alarm output for soiling display
- ✓ 2-way selectable transmitting frequency
- ✓ 4-way selectable dominant output
- ✓ selectable light-on / dark-on mode

- status display yellow LED
- regulation green LED
- alarm red LED
- turn-on delay
- turn-off delay
- transmitting frequency 2x yellow LED
- dominant output 2x green LED
- test / reset button

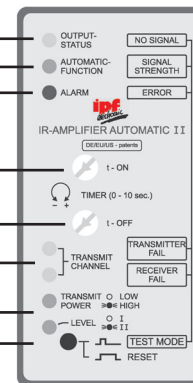

TECHNICAL DATA 1 channel automatic amplifier, relay output, transistor output, alarm output, time delay

article-no.	OV580515 (DC device)	OV580915 (DC device)
article-no.	OV584515 (AC device)	OV584915 (AC device)
operating voltage	24V DC / ±20% / 2.2W	24V DC / ±20% / 2.2W
operating voltage	230V AC / ±10% / 4.8VA	230V AC / ±10% / 4.8VA
transistor output	nnp/pnp, max. 30V DC / 100mA	-
sampling frequency (transistor)	low: 20Hz / high: 11Hz	-
relay output	-	1 change-over contact: 5A / 230V AC (24V DC)
sampling frequency (relay)	-	low: 20Hz / high: 11Hz
alarm output	pnp, 24V DC, DC: 100mA, AC: 5mA pulsed infrared light: 3.7 / 4.1kHz	pnp, 24V DC, DC: 100mA, AC: 5mA pulsed infrared light: 3.7 / 4.1kHz
measuring system	automatic	automatic
transmitting power	automatic	automatic
operating distance (stand./incr./max.)	15/25/50m (7/10/20m for OE126303)	15/25/50m (7/10/20m for OE126303)
dominant output	low 1 / low 2 / high 1 / high 2	low 1 / low 2 / high 1 / high 2
teach input	-	-
switching delay	0 ... 10sec	0 ... 10sec
switching function	light-on / dark-on mode (no / nc) selectable	light-on / dark-on mode (no / nc) selectable
test input	0 ... 30V DC	0 ... 30V DC
housing material	plastic	plastic
system of protection (EN 60529)	IP 40	IP 40
operating temperature	-25 ... +50°C	-25 ... +50°C
connection	pluggable into 11-pin socket	pluggable into 11-pin socket
transmitter and receiver / accessories	see page 34 to 38	see page 34 to 38

DIP switch position

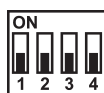

	1	2	3		4	
dominant output			switching function		transm. frequency	
high 2	ON	ON	dark	ON	4,1 kHz	ON
high 1	ON	OFF	light	OFF	3,7 kHz	OFF
low 2	OFF	ON				
low 1	OFF	OFF				

Manufacturer's settings highlighted grey.

dimensional drawing

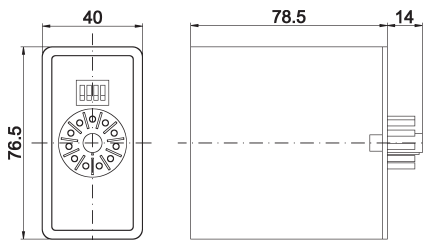

connection

operating voltage

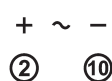

transistor output

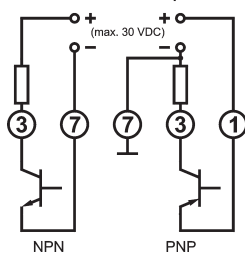

relay

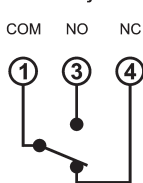

transmitter

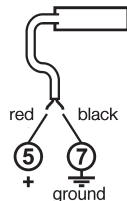

receiver

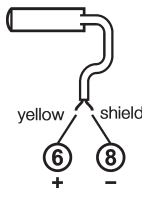

alarm output

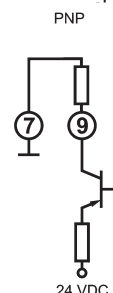

test input

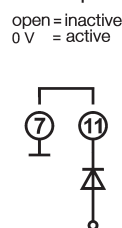

through-beam sensors, amplifiers 3100

- ✓ up to 50m operating distance
- ✓ transistor switching output pnp / npn
- ✓ relay output
- ✓ alignment mark via test function
- ✓ teach-in
- ✓ test input for disabling the transmitter
- ✓ alarm output for soiling display
- ✓ 2-way selectable transmitting frequency
- ✓ 2-way selectable dominant output
- ✓ selectable light-on / dark-on mode

status display yellow LED
regulation green LED
alarm red LED

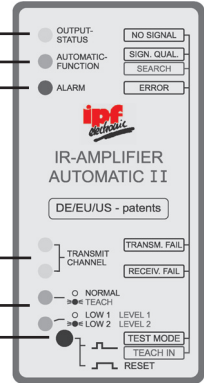

transmitting frequency 2x yellow LED
dominant output 2x green LED
test / reset button

TECHNICAL DATA

1 channel automatic amplifier, relay output, transistor output, alarm output, teach-in

article-no.	OV580530 (DC device)	OV580930 (DC device)
article-no.	OV584530 (AC device)	OV584930 (AC device)
operating voltage	24V DC / ±20% / 2.2W	24V DC / ±20% / 2.2W
operating voltage	230V AC / ±10% / 4.8VA	230V AC / ±10% / 4.8VA
transistor output	nnp/pnp, max. 30V DC / 100mA	-
sampling frequency (transistor)	20Hz	-
relay output	-	1 change-over contact: 5A / 230V AC (24V DC)
sampling frequency (relay)	-	20Hz
alarm output	pnp, 24V DC, DC:100mA, AC: 5mA	pnp, 24V DC, DC:100mA, AC: 5mA
measuring system	pulsed infrared light: 3.7 / 4.1kHz	pulsed infrared light: 3.7 / 4.1kHz
transmitting power	automatic	automatic
operating distance (stand./incr./max.)	15/25/50m (7/10/20m for OE126303)	15/25/50m (7/10/20m for OE126303)
dominant output	low 1 / low 2	low 1 / low 2
teach input	level 1 / level 2	level 1 / level 2
switching delay	-	-
switching function	light-on / dark-on mode (no / nc) selectable	light-on / dark-on mode (no / nc) selectable
test input	0 ... 30V DC	0 ... 30V DC
housing material	plastic	plastic
system of protection (EN 60529)	IP 40	IP 40
operating temperature	steckbar in 11-poligen Sockel	steckbar in 11-poligen Sockel
connection	pluggable into 11-pin socket	pluggable into 11-pin socket
transmitter and receiver / accessories	see page 34 to 38	see page 34 to 38

DIP switch position



	1	2	3		4	
operational mode			switching function		transm. frequency	
teach 2	ON	ON	dark	ON	4,1 kHz	ON
teach 1	ON	OFF	light	OFF	3,7 kHz	OFF
low 2	OFF	ON				
low 1	OFF	OFF				

Manufacturer's settings highlighted grey.

dimensional drawing

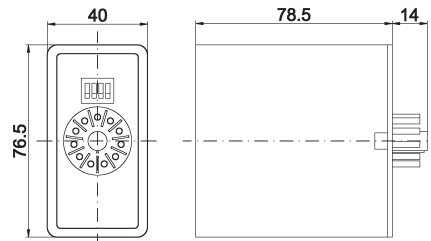

connection

operating voltage

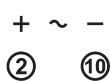

transistor output

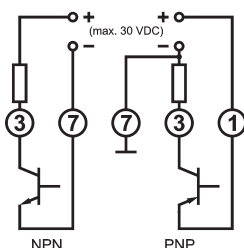

relay

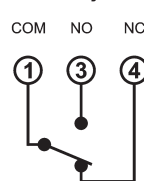

transmitter

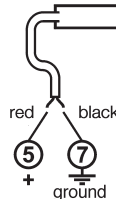

receiver

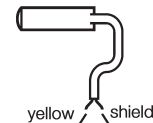

alarm output

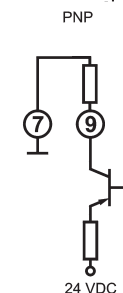

test input

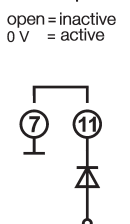

- ✓ up to 70m operating distance
- ✓ sensor alignment and test function via analog output
- ✓ 0 to 10V DC (connection of a measuring instrument)
- ✓ relay output
- ✓ transistor output pnp / npn
- ✓ test input
- ✓ sensitivity adjustable with rotary knob
- ✓ 2-way selectable transmitting frequency
- ✓ 20% / 100% selectable dominant output
- ✓ selectable light-on / dark-on mode

- status display yellow LED
- intensity green LED
- analog output 0 ... 10V DC
- connection for measuring line
- sensitivity adjustment
- transmitting error red LED
- receiver error red LED
- operating voltage green LED

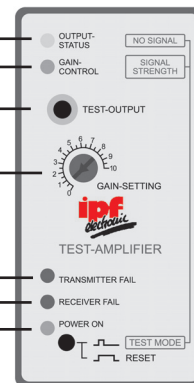

TECHNICAL DATA

1 channel measuring amplifier, relay output, transistor output, analog output

article-no.	OV580080 (DC device)
article-no.	OV584080 (AC device)
operating voltage	24V DC / ±20% / 2.0W
operating voltage	230V AC / ±10% / 4.2VA
relay output	1 change-over contact: 5A / 230V AC (24V DC)
sampling frequency (relay)	18Hz
transistor output (AC devices)	npn: 0.1A (30V DC), pnp: 5mA (12V DC)
transistor output (DC devices)	npn / pnp: 0.1A (30V DC)
sampling frequency (transistor)	30Hz
analog outout	0 ... 10 / 10 ... 0V DC
alarm output	-
measuring system	pulsed infrared light: 3.5 / 4.4kHz selectable
transmitting power	-
operating distance (stand./incr./max.)	25/35/70m (10/15/35m for OE126303)
dominant output	20% / 100%
teach input	-
switching delay	-
switching function	light-on / dark-on mode
test input	24V DC
housing material	plastic
system of protection (EN 60529)	IP 40
operating temperature	-25 ... +50°C
transmitter and receiver / accessories	see page 34 to 38

DIP switch position

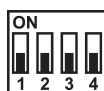

	1		2		3		4	
	dominant output		switching function		output voltage		transmitting frequency	
20%	ON	dark	ON	10-0V	ON	3,5kHz	ON	
100%	OFF	light	OFF	0-10V	OFF	4,4kHz	OFF	

Manufacturer's settings highlighted grey.

dimensional drawing

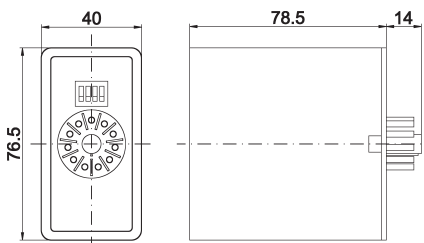

connection

operating voltage

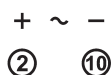

relay

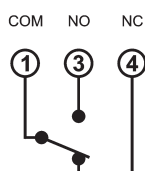

transmitter

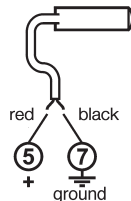

receiver

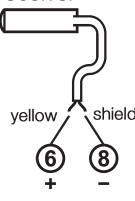

transistor output

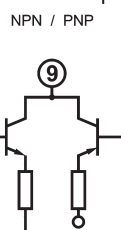

test input



export division

Kalver Straße 27
D-58515 Lüdenscheid

Fon +49 (0) 2351 / 98597-0
Fax +49 (0) 2351 / 98597-29

3100 through-beam sensors, amplifiers**notes****export division**

Kalver Straße 27
D-58515 Lüdenscheid

Fon +49 (0) 2351 / 98597-0
Fax +49 (0) 2351 / 98597-29



design **100 x 75 x 110mm**
to
149 x 75 x 110mm

through-beam sensor operating distance **up to 55m**

sensor

- ✓ plastic housing Ø10mm
- ✓ metal sleeve nickel-plated brass or stainless steel M12x1mm
- ✓ aluminium housing 12x12mm
- ✓ connection to amplifier
- ✓ threaded devices to Euronorm
- ✓ large sensing ranges

amplifier

- ✓ up to 55m operating distance depending on type of through-beam sensor
- ✓ relay or transistor switching output
- ✓ alignment mark via test function
- ✓ teach input
- ✓ test input for disabling the transmitter
- ✓ alarm output for soiling display
- ✓ up to 4-way selectable transmitting frequency
- ✓ turn-on and turn-off delay 0 ... 10sec
- ✓ up to 4-way selectable dominant output
- ✓ selectable light-on / dark-on mode
- ✓ automatic self-test
- ✓ plug-in base connection



up to 55m operating distance depending on through-beam sensor type

description

The high-performance through-beam sensor systems have been engineered specifically for applications where conventional light barriers have reached their limits. They excel in their extreme insensitivity to soiling and in their sensing range and are ideally suited to difficult applications, where up till now only compromise solutions have existed. Thanks to the high performance of the systems, significant penetration is ensured even under conditions of heavy soiling. Chips, dust, flour, oil or dirty water no longer present any obstacle. They are thus perfectly suited for applications in the wood and paper industry, for car-washes, for the control of bulk materials, in elevators, for door

controls out in the open, in the food processing industry, etc. Each system comprises one sensor, one receiver and one amplifier. The transmitters and receivers, in various very compact robust designs, can be accommodated in any construction.

Their large angle of beam spread facilitates their alignment with each other even for sensing ranges of 35m. At the same time they are insensitive to vibration, shock and a resulting loss of alignment.

The high level of user-friendliness is underlined by the ease of installation of the amplifier and sensors as well as by the uncomplicated operation of the devices.

The multiplexers of the OV series operate, as the name already suggests, in multiplex mode. The connected light barriers are addressed one after the other in such a way that they do not mutually influence each other. In both the 4 and 8 channel versions it is even possible to increase their number by con-

necting them in series. As before, some of the devices are processor-controlled and operate with modulated infrared light, which provides high external light shielding. The switching operation has been laid out in such a way that only signals of the correct frequency and phase position are recognized.

alarm display

see alarm output

alarm output "alarm"

A signal is transmitted before the output limit is reached. The red LED on the amplifier lights up at the same time. The system nevertheless continues to be fully functional.

turn-off delay

The turn-off delay is the period between release (light-on mode) or interruption (dark-on mode) of the infrared beam and the switchover of the switching output.

automatic mode

The automatic amplifiers represent a logical further development of the light barrier amplifiers. The amplifiers automatically adapt the transmitting power to the prevailing environmental conditions, permanently compensating 100% for any effects on the system resulting from interference. The switching point is constant over the full power band width and reproducible.

turn-on delay

The turn-on delay is the time period between interruption (light-on mode) or release (dark-on mode) of the infrared beam and the switchover of the switching output.

dominant output

Some devices have selectable output ranges.

intensity display

The green intensity display is permanently lit whenever the transmitting power is sufficient. If the display flashes or goes out completely, then either the transmitting power has been set too low, the transmitter and/or receiver lenses are too soiled for the set transmitting power, the distance between transmitter and receiver is too great or the transmitter and receiver have been incorrectly adjusted out of tolerance.

light curtain

Only one relay or transistor output (channel 1) will react in the case that one of the light barriers is interrupted.

manual operation

Using the control the user can set the transmitting power to the desired degree. Any change of the environmental conditions requires a readjustment.

master-slave operation

The number of light barriers can be increased even further by connecting multiplexers in series.

control system display

The green control system display is permanently lit while the automatic transmitting setting is active. Whenever it goes out the control has been stopped.

relay output

The relay output, executed as a make contact or a changeover contact, comes in a floating version (depending on type) that reacts to any interruption of the light barrier.

switching function

The switching function describes the behavior of the switching output in case of the infrared beam has been interrupted. In the dark-on mode "dark" an output signal is generated if the light beam is interrupted. In the light-on mode "light" no output signal is generated if the light beam is interrupted.

delay

The turn-on delay or turn-off delay delays the reaction of the output by a time that is adjustable between 0...15sec.

status display

The yellow switching status display lights up when the switching output or the relay output is active.

transmitting frequency

The transmitting frequency is the frequency with which the amplifier transmits. Some versions can be operated with different frequencies.

transmitter and receiver connections

All transmitter and receiver connections of the amplifiers have short-circuit protection. Even in case of an unintentional short-circuit it is impossible to damage the inputs.

test function

The amplifier signals the user whether or not an error has cropped up on the transmitter or the receiver side. For any non-existence of an error the test function will display the quality of the passing. A LED has been provided for the display, which can flash 1 to 10 times with the flashing being proportional to the signal that is received.

transistor output

These outputs can be used as NPN output or PNP output depending on the external switching.

through-beam sensors, amplifiers 3100

- ✓ up to 50m operating distance
- ✓ sensitivity adjustable per channel with rotary knob
- ✓ relay output per channel
- ✓ 20% / 100% selectable dominant output
- ✓ selectable light-on / dark-on mode per channel
- ✓ 16msec / 8msec selectable multiplex speed

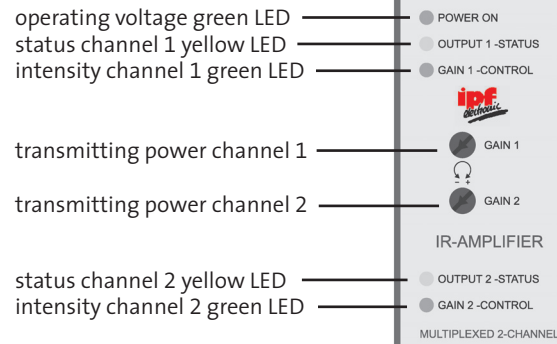

TECHNICAL DATA

2 channel multiplexer, relay output

article-no.	OV580920 (DC device)
article-no.	OV584920 (AC device)
operating voltage	24V DC / ±20% / 2.0W
operating voltage	230V AC / ±10% / 4.1VA
relay output	2 x normally open contact: each 5A / 230V AC (24V DC)
sampling frequency	20 Hz
alarm output	-
measuring system	modulated infrared light, 4kHz
operating distance (stand./incr./max.)	20/30/50m (10/15/25m for OE126303)
multiplex speed	16msec / 8msec
master-slave operation	-
light curtain function	-
dominant output	20% / 100%
switching delay	-
switching function	light-on / dark-on mode
housing material	plastic
system of protection (EN 60529)	IP 40
operating temperature	-25 ... +50°C
connection	pluggable into 11-pin socket
transmitter and receiver / accessories	see page 34 to 38

DIP switch position



1		2		3		4	
switching function		channel 2		dominant output		multiplex speed	
channel 1	channel 2						
dark	ON	dark	ON	100%	ON	16msec	ON
light	OFF	light	OFF	20%	OFF	8msec	ON

Manufacturer's settings highlighted grey.

dimensional drawing

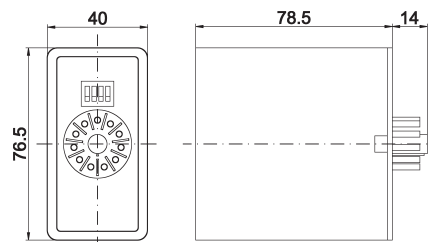

connection

operating voltage

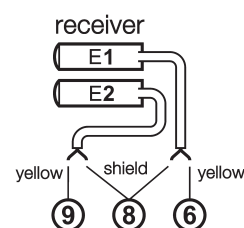
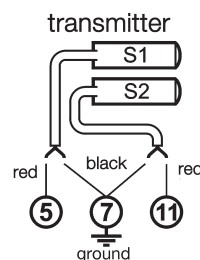
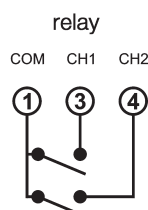
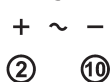

- ✓ up to 50m operating distance
- ✓ sensitivity adjustable per channel with rotary knob
- ✓ 1 relay output per channel
- ✓ selectable turn-on and turn-off delay per channel
- ✓ 20% / 100% selectable dominant output
- ✓ selectable light-on / dark-on mode per channel
- ✓ 16msec / 8msec selectable multiplex speed

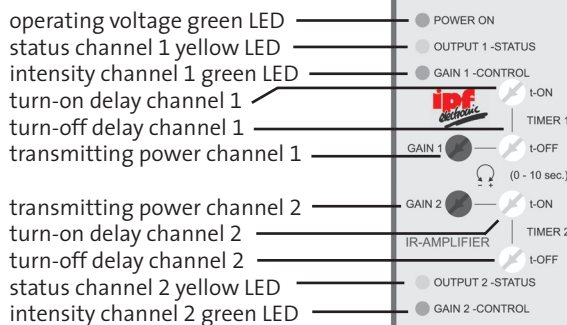

TECHNICAL DATA

2 channel multiplexer, relay output, time delay

article-no.	OV580925 (DC device)
article-no.	OV584925 (AC device)
operating voltage	24V DC / ±20% / 2.0W
operating voltage	230V AC / ±10% / 4.1VA
relay output	2 x normally open contact: each 5A / 230V AC (24V DC)
sampling frequency	20Hz
alarm output	-
measuring system	modulated infrared light, 4kHz
operating distance (stand./incr./max.)	20/30/50m (10/15/25m for OE126303)
multiplex speed	16msec / 8msec
master-slave operation	-
light curtain function	-
dominant output	20% / 100%
switching delay	0 ... 15 sec
switching function	light-on / dark-on mode
housing material	plastic
system of protection (EN 60529)	IP 40
operating temperature	-25 ... +50°C
connection	pluggable into 11-pin socket
transmitter and receiver / accessories	see page 34 to 38

DIP switch position



1		2		3		4	
switching function channel 1		switching function channel 2		dominant output		multiplex speed	
dark	ON	dark	ON	100%	ON	16msec	ON
light	OFF	light	OFF	20%	OFF	8msec	ON

Manufacturer's settings highlighted grey.

dimensional drawing

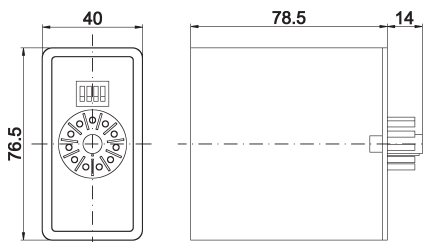

connection

operating voltage

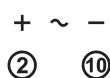

relay

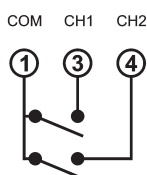

transmitter

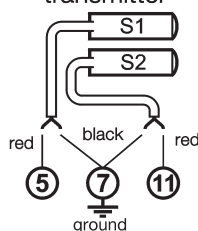

receiver

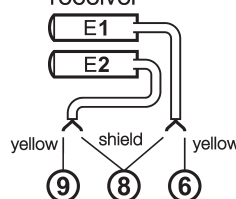

through-beam sensors, amplifiers 3100

- ✓ up to 40m operating distance
- ✓ automatic transmitting power switchover
- ✓ test function for checking the passing quality and the mounting
- ✓ 1 relay output per channel
- ✓ 4-way selectable dominant output
- ✓ selectable light-on / dark-on mode per channel

status channel 1 yellow LED
 regulation channel 1 green LED
 alarm channel 1 red LED

status channel 2 yellow LED
 regulation channel 2 green LED
 alarm channel 2 red LED
 operational mode multi-color LED
 test /reset button

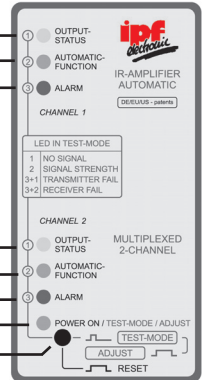

TECHNICAL DATA

2 channel automatic multiplexer, relay output

article-no.	OV580940 (DC device)
article-no.	OV584940 (AC device)
operating voltage	24V DC / ±20% / 2.0W
operating voltage	230V AC / ±10% / 4.0VA
relay output	2 x normally open contact: each 5A / 230V AC (24V DC)
reaction time	max. 8msec
alarm output	-
measuring system	modulated infrared light, 4kHz
operating distance (stand./incr./max.)	13/20/40m (7/9/15m for OE126303)
multiplex speed	4msec
master-slave operation	-
light curtain function	-
dominant output	low 1 / low 2 / high 1 / high 2
switching delay	-
switching function	light-on / dark-on mode
housing material	plastic
system of protection (EN 60529)	IP 40
operating temperature	-25 ... +50°C
connection	pluggable into 11-pin socket
transmitter and receiver / accessories	see page 34 to 38

DIP switch position

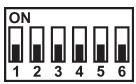

	1	2	3	4	5	6	
channel 1		channel 2		channel 1		channel 2	
dominant output	switching function	dominant output	switching function	dominant output	switching function	dominant output	switching function
high 2	ON	ON	dark	ON	high 2	ON	ON
high 1	ON	OFF	dark	ON	high 1	OFF	OFF
low 2	OFF	ON	light	OFF	low 2	ON	ON
low 1	OFF	OFF	light	OFF	low 1	OFF	OFF

Manufacturer's settings highlighted grey.

dimensional drawing

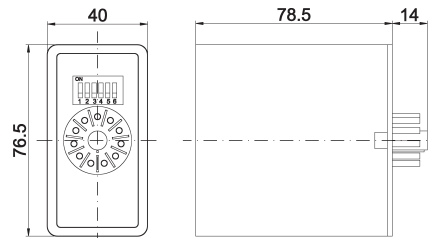

connection

operating voltage

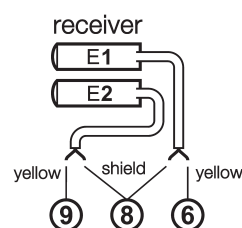
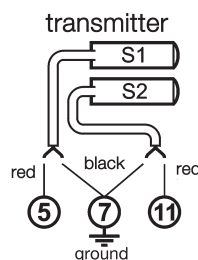
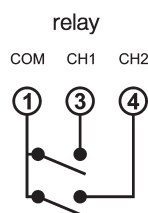
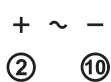

- ✓ up to 40m operating distance
- ✓ sensitivity adjustable per channel with rotary knob
- ✓ 1 transistor switching output pnp / npn per channel
- ✓ turn-on and turn-off delay for channel 1
- ✓ 20% / 100% selectable dominant output
- ✓ 32msec / 16msec selectable multiplex speed
- ✓ master-slave operation
- ✓ light curtain function

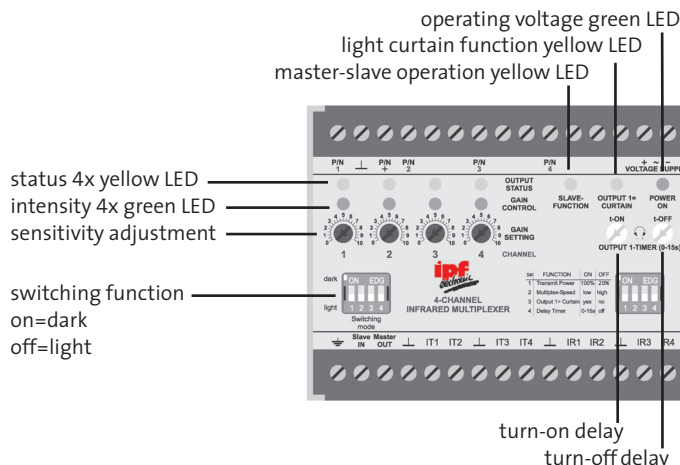

TECHNICAL DATA

4 channel multiplexer, transistor output, time delay

article-no.	OV540520
operating voltage	24V DC / ±20% / 4.5W
transistor output	4 x npn/pnp, max. 30V DC / 20mA
sampling frequency	28Hz
alarm output	-
measuring system	modulated infrared light, 4kHz
operating distance (stand./incr./max.)	20/30/40m (10/15/20m for OE126303)
multiplex speed	32msec / 16msec
master-slave operation	+
light curtain function	+
dominant output	20% / 100%
switching delay	0 ... 15sec
switching function	light-on / dark-on mode
housing material	plastic
system of protection (EN 60529)	IP 20
operating temperature	-25 ... +50°C
connection	terminal strip 4mm ²
transmitter and receiver / accessories	see page 34 to 38

DIP switch position



	1	2	3	4
dominant output		multiplex speed	light curtain	switching delay
100%	ON	32msec	ON	ON
20%	OFF	16msec	OFF	OFF

Manufacturer's settings highlighted grey.

dimensional drawing

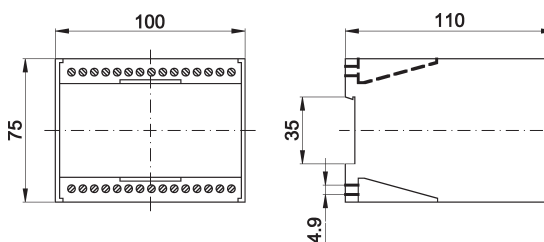

connection

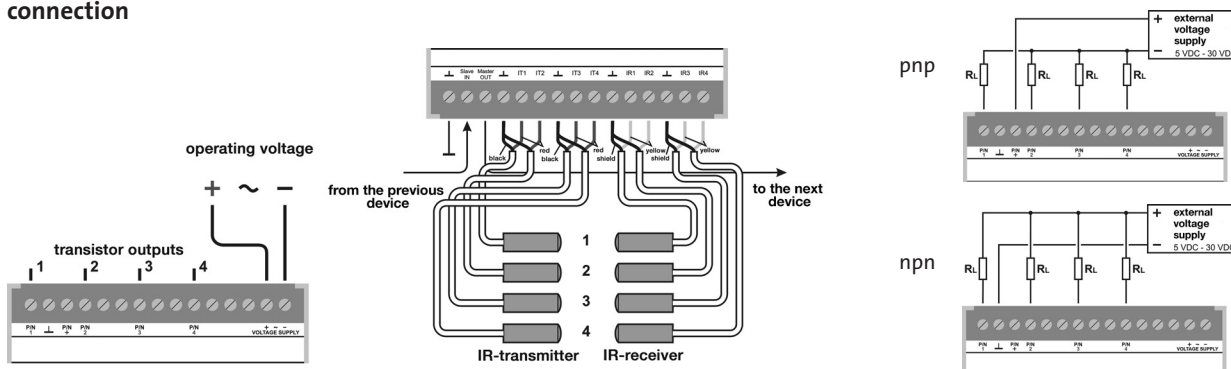

through-beam sensors, amplifiers 3100

- ✓ up to 40m operating distance
- ✓ sensitivity adjustable per channel with rotary knob
- ✓ 1 relay output per channel
- ✓ turn-on and turn-off delay for channel 1
- ✓ 20% / 100% selectable dominant output
- ✓ selectable light-on / dark-on mode per channel
- ✓ 32msec / 16msec selectable multiplex speed
- ✓ master-slave operation
- ✓ light curtain function

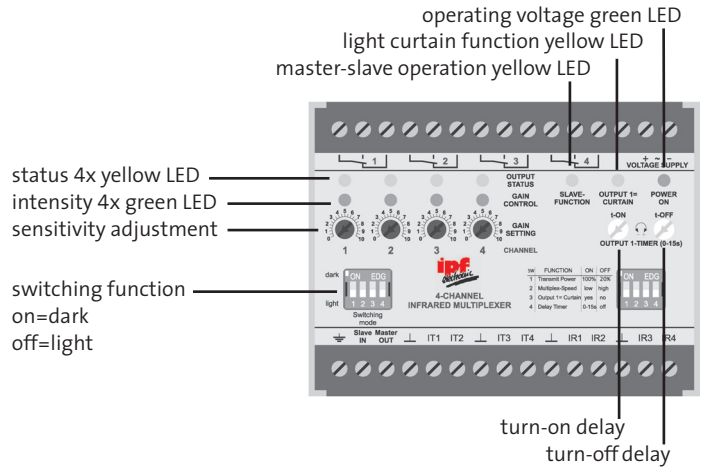

TECHNICAL DATA

4 channel multiplexer, relay output, time delay

article-no.	OV540920 (DC device)
article-no.	OV544920 (AC device)
operating voltage	24V DC / $\pm 20\%$ / 4.5W
operating voltage	230V DC / $\pm 10\%$ / 6.0VA
relay output	4 change-over contacts: each 5A, 230V AC (24V DC)
sampling frequency	20Hz
alarm output	-
measuring system	modulated infrared light, 4kHz
operating distance (stand./incr./max.)	20/30/40m (10/15/20m for OE126303)
multiplex speed	32msec / 16msec
master-slave operation	+
light curtain function	+
dominant output	20% / 100%
switching delay	0 ... 15sec
switching function	light-on / dark-on mode
housing material	plastic
system of protection (EN 60529)	IP 20
operating temperature	-25 ... +50°C
connection	terminal strip 4mm ²
transmitter and receiver / accessories	see page 34 to 38

DIP switch position



1		2		3		4	
dominant output		multiplex speed		light curtain		switching delay	
100%	ON	32msec	ON	ON	ON	ON	ON
20%	OFF	16msec	OFF	OFF	OFF	OFF	OFF

Manufacturer's settings highlighted grey.

dimensional drawing

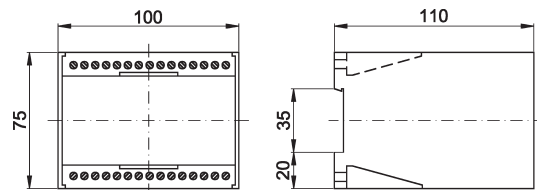

connection

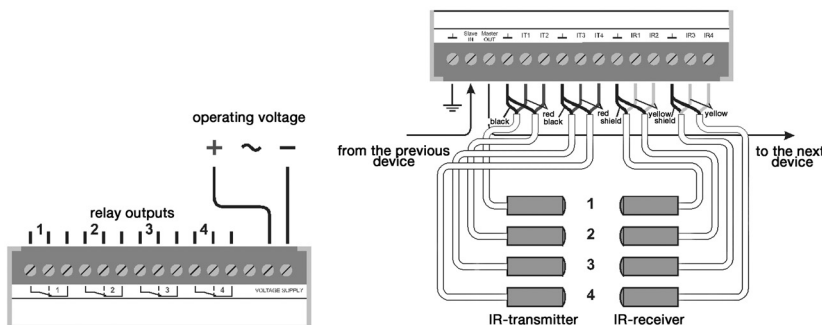

- ✓ up to 40m operating distance
- ✓ sensitivity adjustable per channel with rotary knob
- ✓ 1 relay output per channel
- ✓ turn-on and turn-off delay for channel 1
- ✓ 20% / 100% selectable dominant output
- ✓ selectable light-on / dark-on mode per channel
- ✓ 68msec / 34msec selectable multiplex speed
- ✓ master-slave operation
- ✓ light curtain function

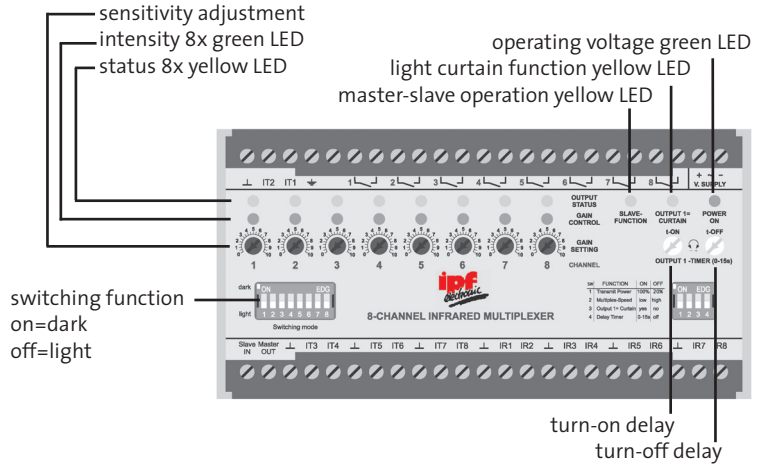

TECHNICAL DATA

8 channel multiplexer, relay output, time delay

article-no.	OV590920 (DC device)
article-no.	OV594920 (AC device)
operating voltage	24V DC / ±20% / 8.0W
operating voltage	230V DC / ±10% / 10.0VA
relay output	8 normally open contacts: each 5A, 230V AC (24V DC)
sampling frequency	15Hz
alarm output	-
measuring system	modulated infrared light, 4kHz
operating distance (stand./incr./max.)	20/30/40m (10/15/20m for OE126303)
multiplex speed	68msec / 34msec
master-slave operation	+
light curtain function	+
dominant output	20% / 100%
switching delay	0 ... 15sec
switching function	light-on / dark-on mode
housing material	plastic
system of protection (EN 60529)	IP 20
operating temperature	-25 ... +50°C
connection	terminal strip 4mm ²
transmitter and receiver / accessories	see page 34 to 38

DIP switch position

dimensional drawing



	1		2		3		4	
	dominant output	multiplex speed	light curtain	switching delay	dominant output	multiplex speed	light curtain	switching delay
100%	ON	68msec	ON	ON	ON	ON	ON	ON
20%	OFF	34msec	OFF	OFF	OFF	OFF	OFF	OFF

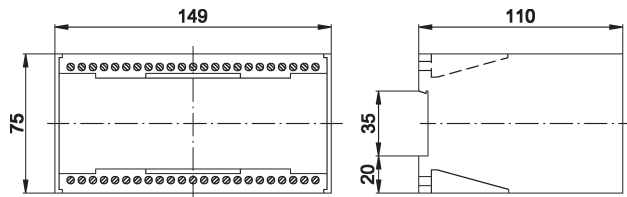

Manufacturer's settings highlighted grey.

connection

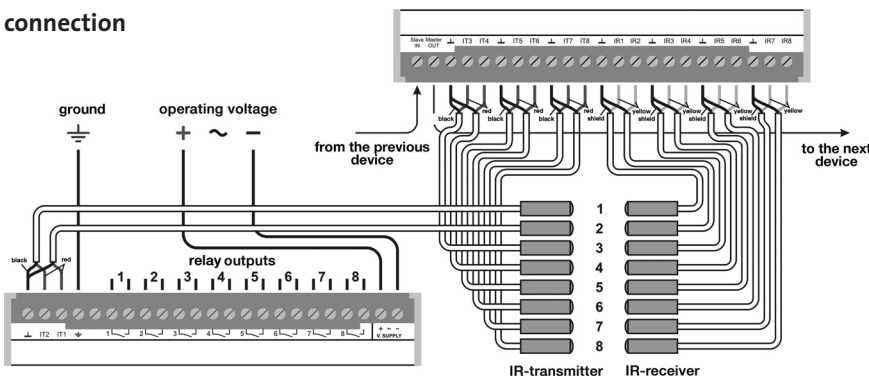

through-beam sensors, amplifiers 3100

- ✓ up to 55m operating distance
- ✓ automatic transmitting power adjustment
- ✓ test function for checking the passing quality and the mounting
- ✓ 1 relay output per channel
- ✓ turn-on, turn-off and regulation delay programmable per channel
- ✓ selectable light on / dark-on mode per channel
- ✓ 2-way programmable dominant output
- ✓ master-slave operation

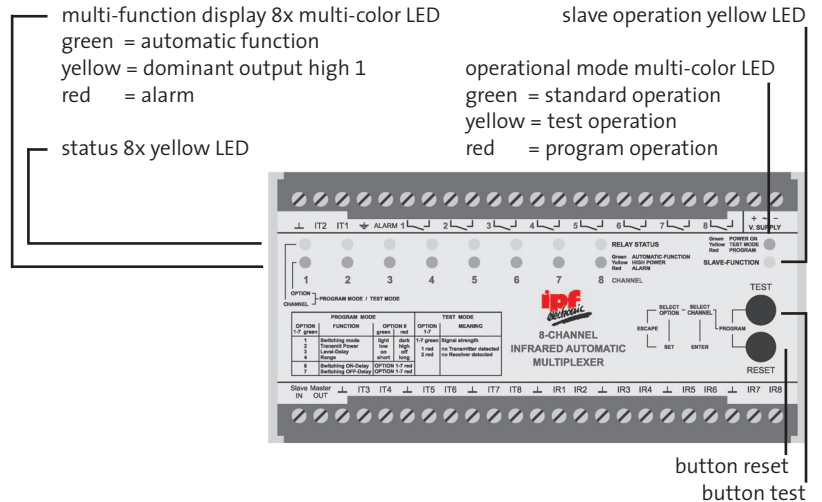

TECHNICAL DATA	8 channel automatic multiplexer, relay output, alarm output, time delay
article-no.	OV590935 (DC device)
article-no.	OV594935 (AC device)
operating voltage	24V DC / ±20% / 8.0W
operating voltage	230V DC / ±10% / 10.0VA
relay output	8 normally open contacts: each 5A, 230V AC (24V DC)
sampling frequency	15Hz
alarm output	pnp, 24V DC / 100mA (AC: 5mA)
measuring system	modulated infrared light, 4kHz
operating distance (stand./incr./max.)	15/20/55m (8/10/20m for OE126303)
multiplex speed	34msec
master-slave operation	+
light curtain function	-
dominant output	low / high
switching delay	0 ... 7sec
switching function	light-on / dark-on mode
housing material	plastic
system of protection (EN 60529)	IP 20
operating temperature	-25 ... +50°C
connection	terminal strip 4mm ²
transmitter and receiver / accessories	see page 34 to 38

dimensional drawing

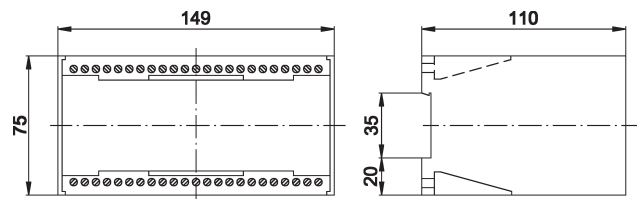

connection

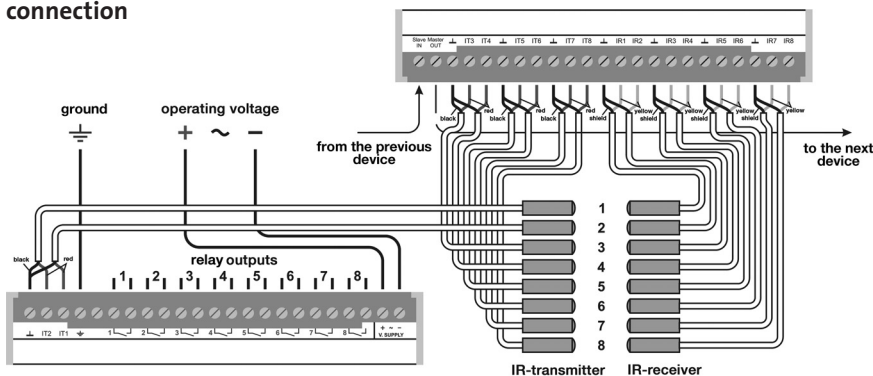

transmitter and receiver

fig. 1

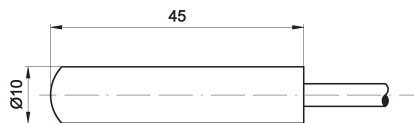

fig. 2

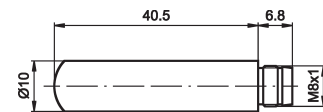

fig. 3

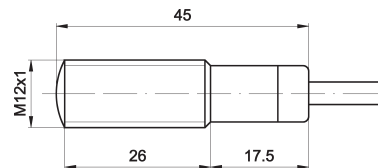

fig. 4

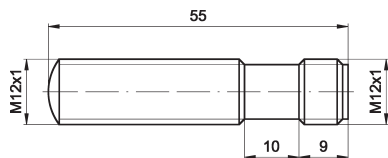

fig. 5

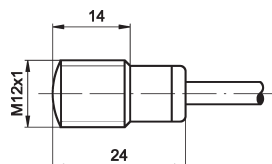

fig. 6

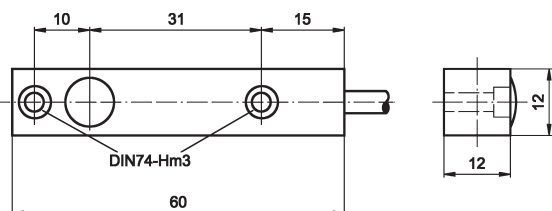
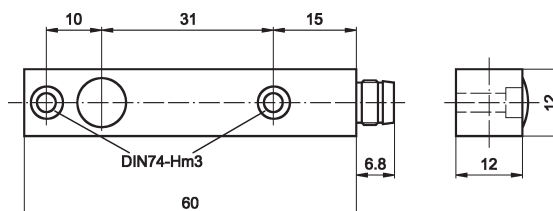

fig. 7



article-no.	transmitter / receiver	sampling frequency	angle of beam spread	transmitting power	operating distance*	operating temperature	material	connection	fig.
OS106001	transmitter		12°	40mW / Sr	normal	-25 ... +60°C	plastic	cable, 5m	1
OS106101	transmitter		6°	350mW / Sr	maximal	-25 ... +60°C	plastic	cable, 5m	1
OE106001	receiver	15Hz	25°			-25 ... +60°C	plastic	cable, 5m	1
OS106003	transmitter		12°	40mW / Sr	normal	-25 ... +60°C	plastic	cable, 5m	1
OE106003	receiver	15Hz	25°			-25 ... +60°C	plastic	cable, 5m	1
OS106070	transmitter		12°	40mW / Sr	normal	-25 ... +60°C	plastic	M8-connector	2
OS106170	transmitter		6°	350mW / Sr	maximal	-25 ... +60°C	plastic	M8-connector	2
OE106070	receiver	15Hz	25°			-25 ... +60°C	plastic	M8-connector	2
OS126001	transmitter		12°	40mW / Sr	normal	-25 ... +60°C	n-pltd. brass	cable, 5m	3
OS1260V1	transmitter		12°	40mW / Sr	normal	-25 ... +60°C	stainl. steel	cable, 5m	3
OS126101	transmitter		6°	350mW / Sr	maximal	-25 ... +60°C	stainl. steel	cable, 5m	3
OE126001	receiver	15Hz	25°			-25 ... +60°C	n-pltd. brass	cable, 5m	3
OE1260V1	receiver	15Hz	25°			-25 ... +60°C	stainl. steel	cable, 5m	3
OS126003	transmitter		12°	40mW / Sr	normal	-25 ... +60°C	n-pltd. brass	cable, 5m	3
OS126008	transmitter		20°	70mW / Sr	increased	-25 ... +60°C	n-pltd. brass	cable, 5m	3
OE126003	receiver	15Hz	25°			-25 ... +60°C	n-pltd. brass	cable, 5m	3
OS126020	transmitter		12°	40mW / Sr	normal	-25 ... +60°C	stainl. steel	M12-connector	4
OS126120	transmitter		6°	350mW / Sr	maximal	-25 ... +60°C	stainl. steel	M12-connector	4
OS126026	transmitter		20°	70mW / Sr	increased	-25 ... +60°C	stainl. steel	M12-connector	4
OE126020	receiver	15Hz	25°			-25 ... +60°C	stainl. steel	M12-connector	4
OS126303	transmitter		6°	350mW / Sr	maximal	-25 ... +60°C	n-pltd. brass	cable, 15m	5
OE126303	receiver	15Hz	25°			-25 ... +60°C	n-pltd. brass	cable, 15m	5
OS136003	transmitter		12°	40mW / Sr	normal	-25 ... +60°C	aluminium	cable, 15m	6
OE136003	receiver	15Hz	25°			-25 ... +60°C	aluminium	cable, 15m	6
OS136070	transmitter		12°	40mW / Sr	normal	-25 ... +60°C	aluminium	M8-connector	7
OE136070	receiver	15Hz	25°			-25 ... +60°C	aluminium	M8-connector	7

* the operating distance depends on the settings of the used amplifier

connection

cable device transmitter

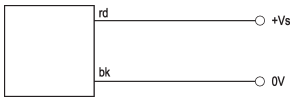

cable device receiver

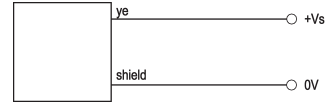

wire colors: rd = red, bk = black, ye = yellow

connector device transmitter

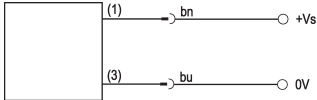

connector device receiver



wire colors: bn = brown (1), bu = blue (3), bk = black (4)

FURTHER ACCESSORIES:

cooler housing **AO000161** for optical sensors M12x1 with cable – stainless steel housing 40x90mm

fiber optics

- ✓ adaptation M12x1
- ✓ suited to screw onto OS/OE12
- ✓ end sleeve made of stainless steel
- ✓ silicone and/or stainless steel sheathing
- ✓ suited for high temperatures

fiber optic head 1

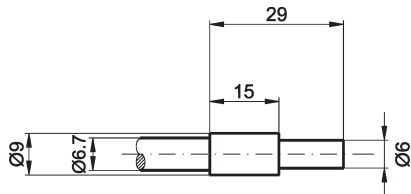

fiber optic head 2

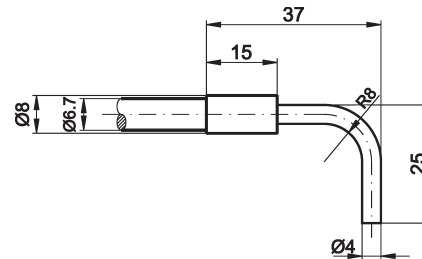

adaptation

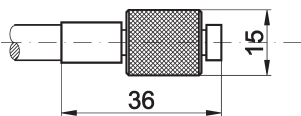

article-no.	length	description	outer jacket	temperature range	glass fiber	adaptation	fiber optic head
LS050916	500mm	fiber optics	silicone	-40 ... +180°C	3.5mm	M12x1	1
LS070916	700mm	fiber optics	silicone	-40 ... +180°C	3.5mm	M12x1	1
LS100916	1000mm	fiber optics	silicone	-40 ... +180°C	3.5mm	M12x1	1
LS200916	2000mm	fiber optics	silicone	-40 ... +180°C	3.5mm	M12x1	1
LS102916	1000mm	fiber optics	stainless steel	-40 ... +300°C	3.5mm	M12x1	1
LS302916	3000mm	fiber optics	stainless steel	-40 ... +300°C	3.5mm	M12x1	1
LS102911	1000mm	fiber optics	stainless steel	-40 ... +300°C	2.8mm	M12x1	2

accessories

fig. 1

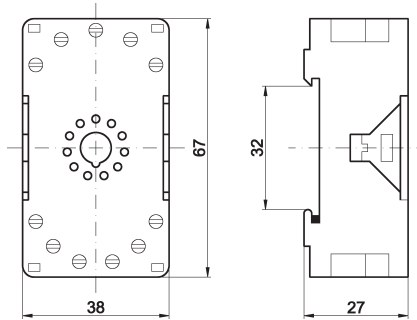

fig. 2

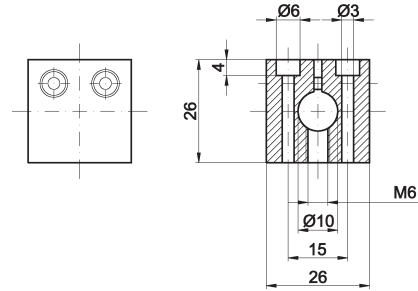

fig. 3

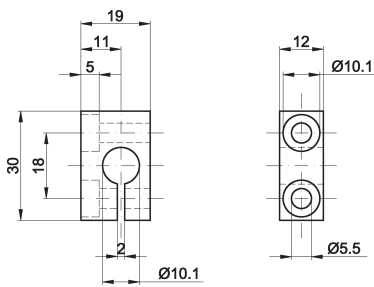

fig. 4

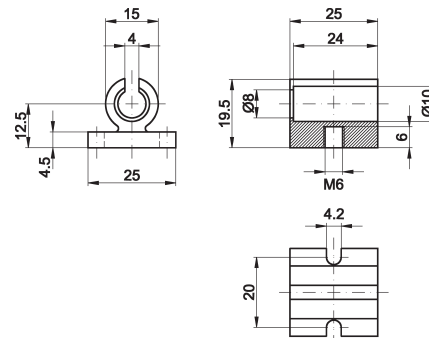

fig. 5

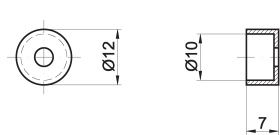

fig. 6

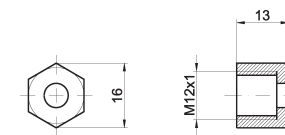
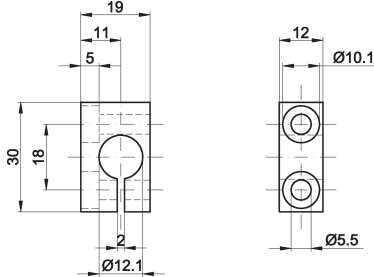

fig. 7



article-no.	description	fig.
AV000004	plug-in base 11-pin, plastic	1
AV000042	spring clip 58, fixing for plug-in base 11-pin, amplifier 58	w/o
AY000004	mounting clip 10 for design 10, plastic, round	2
AY000020	mounting clip 10 for design 10, aluminium, round	3
AY000042	clamp holder 10 for design 10, plastic, round	4
AO000021	aperture diaphragm / 10mm, hole diameter 1mm	5
AO000023	slit diaphragm / 10mm, slit width 1mm	similar to 5
AO000022	aperture diaphragm / M12x1, hole diameter 1mm	6
AO000048	aperture diaphragm, glass / M12x1, hole diameter 1mm	6
AO000064	slit diaphragm / M12x1, slit width 1mm	similar to 6
AO000024	slit diaphragm, glass / M12x1, slit width 1mm	similar to 7
AO000063	aperture diaphragm, glass / M12x1, hole diameter 8mm	similar to 8
AO000095	air purge for optical sensors / M12x1	w/o
AY000032	sensor, clip 12mm, aluminium, for design 12, round	7

protective housing

- ✓ shock-resistant plastic
- ✓ transparent sight cover
- ✓ system of protection IP66
- ✓ cable gland PG7 and PG11

AV000108

protective housing for three amplifiers

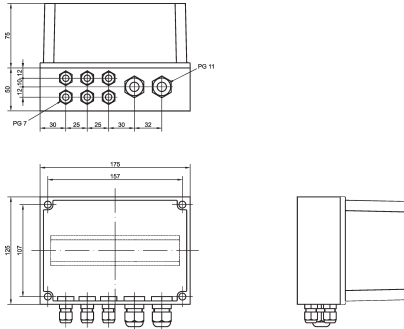

AV000109

protective housing for one 2-way multiplexer

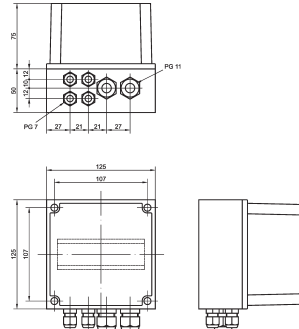

AV000110

protective housing for one 8-way multiplexer

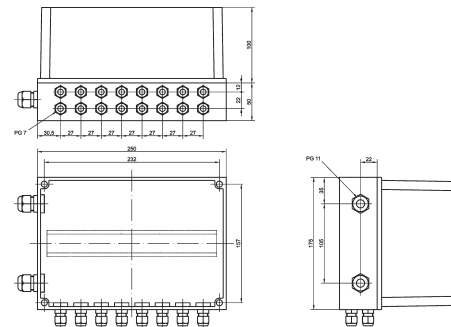

TECHNICAL DATA

	AV000108	AV000109	AV000110
material (base)	polycarbonate (glass fiber reinforced)	polycarbonate (glass fiber reinforced)	polycarbonate (glass fiber reinforced)
material (top)	polycarbonate	polycarbonate	polycarbonate
material (sealing)	polyurethane	polyurethane	polyurethane
system of protection (EN 60529)	IP 66	IP 66	IP 66
shock-resistance (EN 50102)	IK 08	IK 08	IK 08
color (base)	grey (RAL 7035)	grey (RAL 7035)	grey (RAL 7035)
color (top)	smoky	smoky	smoky
operating temperature	-40 ... +80°C	-40 ... +80°C	-40 ... +80°C